

MODBUS to MQTT Gateway BL100



KING PIGEON



BL100 User Manual

Version V1.0

Issue Date: 2021-08-18

King Pigeon Communication Co.,Ltd.

Website: www.iot-solution.com



Preface

Thanks for choosing King Pigeon Modbus to MQTT Gateway BL100. Reading this manual with full attention will help you quickly learn device functions and operation methods.

Copyright

This user manual is owned by King Pigeon Communication Co., Ltd. No one is authorized to copy, distribute or forward any part of this document without written approval of King Pigeon. Any violation will be subject to legal liability.

Disclaimer

If any problem caused by network upgrading of telecommunication service provider, King Pigeon will not be liable for it. This Modbus to MQTT Gateway is mainly used for data transmission through GSM/SMS/GPRS/3G/4G. Please follow the instructions in the manual and pay attention to the tips of GSM/3G/4G wireless products. Any damages caused by wrong operation will be beyond warranty.

Revision History

Revision Date	Version	Description	Owner
Aug 2, 2021	V1.0	Initial Release	XJH

Content

1	Product Introduction.....	5
1.1	General Introduction.....	5
1.2	Application Illustration.....	6
1.3	Safety Introduction.....	7
1.4	Packing List.....	7
1.5	Product Features.....	9
1.6	Technical Parameters.....	10
1.7	Model Selection.....	11
2	Hardware Introduction.....	12
2.1	Outline Dimension.....	12
2.2	LED Indicator.....	13
2.3	Interface Definition.....	13
2.4	Debugging & Upgrading USB Interface.....	14
2.5	Antenna Connection.....	14
3	Product Mounting.....	15
3.1	Wall-Mounting.....	15
3.2	DIN-Rail Mounting.....	15
4	Configuration Software Introduction.....	16
4.1	Preparation before Configuration.....	16
4.1.1	USB Driver Installation.....	16
4.1.2	Search for Port Number.....	16
4.2	Login to Configuration Software.....	17
4.3	Serial Port Configuration.....	18
4.4	Slave Mapping Table.....	19
4.5	Cloud Platform Connection Configuration.....	23
4.5.1	King Pigeon Cloud 3.0.....	24
4.5.2	King Pigeon Cloud 2.0 via Modbus.....	25
4.5.3	King Pigeon Cloud 2.0 via MQTT.....	26
4.5.4	HUAWEI Cloud Configuration.....	28
4.5.5	Alibaba Cloud Configuration.....	29
4.5.6	Other IOT Server (Custom Protocol).....	30
4.6	Device Self-Checking.....	31



4.7 Advanced Functions.....	32
4.7.1 Parameter Configuration.....	32
4.7.2 User Number Setting.....	33
4.7.3 Timer.....	34
4.7.4 Device Firmware Update.....	35
4.7.5 Mapping Register Data.....	36
4.8 Export Configuration File.....	37
4.9 Load Configuration File.....	37
4.10 Factory Reset.....	38
5 Device Application and Cloud Connection Example.....	39
5.1 Transparent Transmission (DTU) Setting.....	39
5.2 Modbus Master and Cloud Connection.....	41
5.2.1 RS485 Serial Port Mode Setting.....	42
5.2.2 King Pigeon Cloud Application.....	44
5.2.3 HUAWEI Cloud Application.....	46
5.2.4 Alibaba Cloud Application.....	51
5.2.5 MQTT Application.....	56
5.2.6 Self-Defined Cloud Platform.....	60
6 Appendix Register Address.....	61
6.1 BL100 Device Register Address.....	61
6.2 Mapping Register Address.....	61
6.3 Edit Boolean Mapping Address Data.....	62
6.4 Read Numeric Mapping Address Data.....	63
6.5 Edit Numeric Mapping Address Data.....	64
6.6 SMS Function.....	65
6.6.1 SMS Commands.....	66
7 After-Sale Service.....	67
7.1 Firmware Upgrading.....	67
7.2 Warranty Term.....	68
7.3 Technical Support.....	68

1 Product Introduction

1.1 General Introduction

- ◆ BL100 is a Modbus to MQTT gateway based on cellular network. It supports Modbus RTU, Modbus TCP, MQTT, Alibaba Cloud, HUAWEI Cloud, King Pigeon Cloud, custom platform and transparent data transmission. Users can connect it to third-party server, cloud platform and SCADA easily.
- ◆ With built-in industrial GSM/GPRS/3G/4G communication module, BL100 has integrated stable and reliable 32-bit MCU based on embedded uCOSII real time operation system
- ◆ It supports Modbus Slave and Modbus Master with up to 320 extended datapoints for data collection. Users can configure high/low limit parameters according to various application requirement. If any threshold is triggered, device will send notification to users via SMS and transmit the data to monitoring center without operator on-site check

1.2 Application Illustration



1.3 Safety Introduction



Safety Notice

Please don't use the device where mobile phones are prohibited



Wireless Interference

This device uses GSM/GPRS/3G/4G wireless network, please pay attention to wireless interference.

1.4 Packing List

Before using the device, please make sure below parts are included in the package
(Below pictures are for reference only. Please follow real product)

- 1x BL100 Gateway



- 1x 4PIN 3.5mm Female Connector



- 1x 8PIN 3.5mm Female Connector



- 1x Micro_USB Cable



- 2 x Wall-Mounting Clip Buckle Kit



- 1 x DIN Rail Clip Buckle Kit



- 1x 2G/3G/4G SMA Cellular Network Antenna



- 1 x Data Card Picking PIN



- 1 x Product Qualification Card



- 1 x Warranty Card



- 1 x User Manual (PDF soft copy)

Note: Please scan QR code to download it.

Note: if any of the above items are missing, please contact King Pigeon sales team

1.5 Product Features

- Use 4G cellular network for communication without range limit
- Support 9~36VDC power supply with reverse connection protection
- 2 channels of built-in DC power output (Output power voltage is equal to input power voltage) to save wiring cost
- Simple and convenient parameter setting with local configuration software and remote SMS
- Built-in software and hardware watchdog to prevent false deadlock
- 1 RS485 serial port, support Modbus RTU to MQTT and transparent transmission
- Serial port baud rate supports 2400bps-115200bps; stop bit supports 1, 2, data bit supports 8, parity bit supports None, Odd, Even
- Support Modbus Slave protocol and can be connected to host computer like SCADA, HMI, DSC, PLC, etc. Support Modbus RTU Master and can connect up to 48 Modbus Slave devices with max 320 datapoints
- Support SMS alarm for monitoring various Modbus data, support configuration software parameter setting and SMS inquiry, if any communication problem, will notify users with SMS
- Use complete offline prevention mechanism to re-transmit offline data and notify users with SMS
- Support remote device restart and parameter setting with SMS
- Support 10 user numbers to receive device disconnection, serial port data beyond limit, and other alarm messages
- Built-in timer function to perform scheduled automatic data reporting, SMS, Arm/Disarm and device restarting
- Support PC configuration software to read, import, export parameters and upgrade firmware through USB interface

- Metal case, IP30 protection grade, metal case and PCBA are isolated safely, applicable in industrial sites
- Compact size, support wall-mounting and 35mm DIN rail mounting

1.6 Technical Parameters

Category	Parameter	Description
Power Supply	Power Voltage	9~36V DC
	Power Consumption	Normal: 50mA@12V, Max: 150mA@12V
	Power Output	<ul style="list-style-type: none"> ● 2 channels ● Output voltage: 9~36V DC(equal to input voltage) ● Output current: 1500mA@12V(Max)
	Power Protection	Reverse connection protection, ESD air: 15KV, surge:4KV
Serial Port	Serial Port Qty	1x RS485
	Baud Rate	1200bps-115200bps
	Data Bit	8
	Parity Bit	None, Even, Odd
	Stop Bit	1,2
	Protocol	Modbus RTU (slave), Modbus RTU (master)
	Protection	ESD contact: 8KV, surge: 4KV (8/20us)
SIM/UIM Card Slot	Slot Qty	1
	Slot Type	Standard drawer type card slot, support 1.8V/3V nano card with built-in 15KV ESD protection
Cellular Network	L-E version	GSM/EDGE:900,1800MHz WCDMA:B1,B5,B8 FDD-LTE:B1,B3,B5,B7,B8,B20 TDD-LTE:B38,B40,B41
	L-CE version	GSM/EDGE:900,1800MHz WCDMA:B1,B8 TD-SCDMA:B34,B39 FDD-LTE:B1,B3,B8 TDD-LTE:B38,B39,B40,B41
	L-A version	WCDMA:B2,B4,B5 FDD-LTE:B2,B4,B12
	L-AU version	GSM/EDGE:850,900,1800MHz WCDMA:B1,B2,B5,B8 FDD-LTE:B1,B3,B4,B5,B7,B8,B28 TDD-LTE:B40
	L-AF version	WCDMA:B2,B4,B5 FDD-LTE:B2,B4,B5,B12,B13,B14,B66,B71
	CAT-1 version	GSM:900,1800 FDD-LTE:B1,B3,B5,B8 TDD-LTE:B34,B38,B39,B40,B41
Software Parameter	Protocol	Modbus RTU, Modbus TCP, MQTT, HUAWEI Cloud, Alibaba Cloud, King Pigeon Cloud
	Protocol Conversion	Support Modbus RTU to MQTT
	Indicator	System running, alarm and RS485 data indicators



	User Configuration	PC configuration software, support WIN XP, WIN 7, WIN 8 and WIN 10
	Slave Connection	Max 48 slave devices can be connected. Up to 320 mapping register addresses (Bool, 16-bit, 32-bit, 64-bit)
	Transparent Transmission	Support transparent transmission
	SMS Commands	Support SMS commands
	Login Package	Support custom login package
	Heartbeat Package	Support custom heartbeat package
Certification	MTBF	≥100,000 hours
	EMC	EN 55022: 2006/A1: 2007 (CE &RE) Class B
		IEC 61000-4-2 (ESD) Level 4
		IEC 61000-4-3 (RS) Level 4
		IEC 61000-4-4 (EFT) Level 4
		IEC 61000-4-5 (Surge)Level 3
		IEC 61000-4-6 (CS)Level 4
IEC 61000-4-8 (M/S) Level 4		
Others	CE, FCC, ROHS	
Environment	Working Condition	-45~85°C, 5~95%RH
	Storage Condition	-45~105°C, 5~95%RH
Others	Case	Metal Case
	Size	83mm×30mm×100mm
	Protection Grade	IP30
	Net Weight	225g
	Mounting	Wall-Mounting/DIN Rail Mounting

1.7 Model Selection

No.	Model	2G/3G/4G	Serial Port (Default is RS485, optional RS232)	Extendable I/O Datapoint Qty			
				Bool	16Bit	32Bit	64Bit
1	BL100	√	1	64	128	64	64
2	BL100Pro	√	2	64	128	64	64

2 Hardware Introduction

2.1 Outline Dimension



2.2 LED Indicator



LED Indicator				
No.	Item	Color	Status	Description
1	Alarm	Green	Steady on	Alarm is triggered
			Off	No Alarm
2	Run	Green	Flickering	Registering data card
			Steady on	Data card is successfully registered and system is running
3	TX	Green	Flickering	Serial port is transmitting data
			Off	No data
4	RX	Green	Flickering	Serial port is receiving data
			Off	No data

2.3 Interface Definition

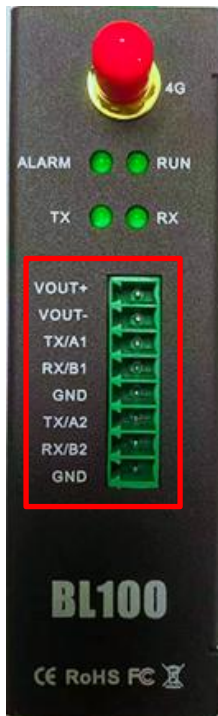

Interface Definition		
No.	Interface	Description
1	VOUT +	2 nd power output positive
2	VOUT -	2 nd power output negative
3	TX/A1	1 st serial port A / TX
4	RX/B1	1 ST serial port B / RX
5	GND	Grounding
6	TX/A2	2 nd serial port A / TX
7	RX/B2	2 nd serial port B / RX
8	GND	Grounding



Interface Definition		
No.	Interface	Description
1	USB	Connect configuration software for parameter setting and program upgrading
2	SIM	Make sure device is powered off before inserting or removing SIM card
3	RESET	In running mode, long press it for 5 seconds. Once all indicators are off and on again, reset is done successfully
4	ON/OFF	Power ON / Power OFF device
5	VOUT+	1 st power output positive
6	VOUT-	1 st power output negative
7	VIN+	Power input positive
8	VIN-	Power input negative
Power off the device first, insert picking PIN to card slot and eject slot with tiny force		

2.4 Debugging & Upgrading USB Interface

Micro USB interface is used to connect configuration software for firmware upgrading. Use standard Micro USB cable to connect this device and PC (CH340 driver must be installed first)

2.5 Antenna Connection

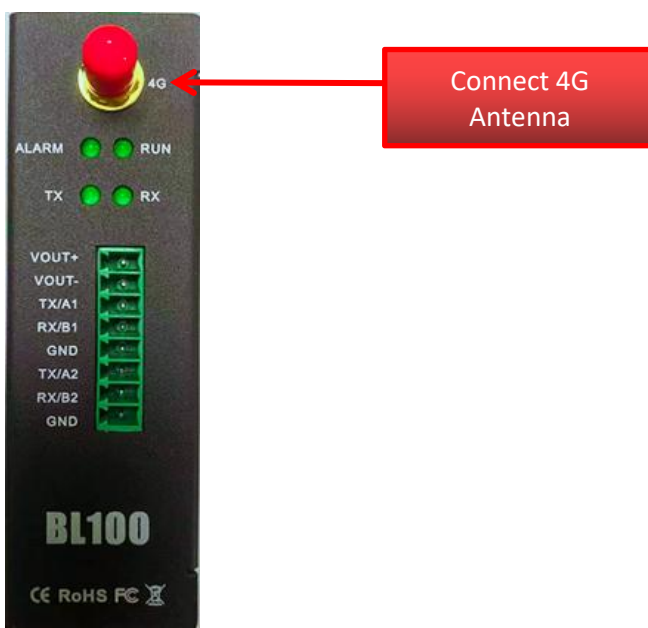

3 Product Mounting

This device supports horizontal placement, wall-mounting and DIN Rail mounting.

3.1 Wall-Mounting

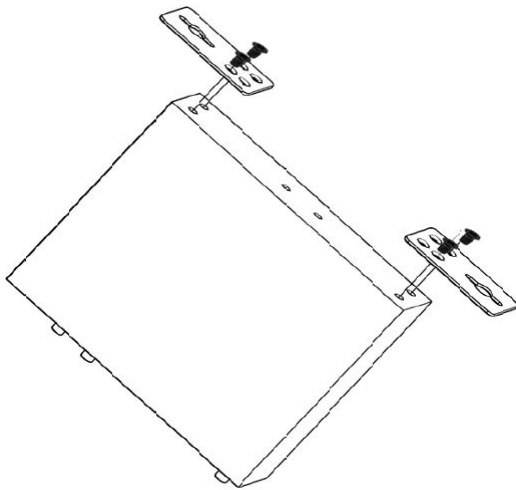

3.2 DIN-Rail Mounting

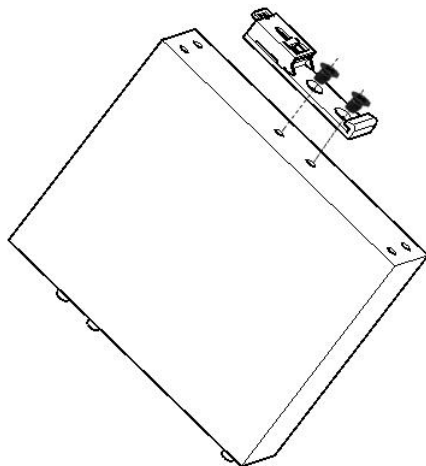

Assemble clip

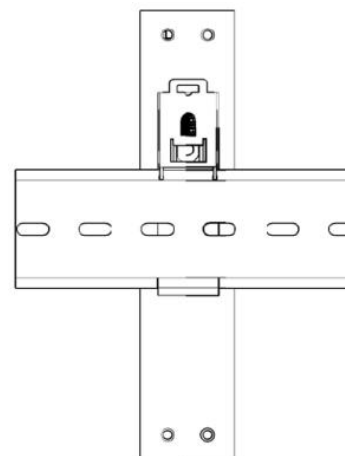

Assemble DIN Rail

4 Configuration Software Introduction

BL100 parameters are configured in PC software. It supports Windows XP/Vista/7/8/10 operation system through Micros USB connection.

4.1 Preparation before Configuration

4.1.1 USB Driver Installation

➤ Option 1

Double click below USB to RS485 driver file. Download and unzip it to install on the computer



➤ Option 2

Download universal driver program, for example, Drive the Life, and install it on the computer.

4.1.2 Search for Port Number

Right click **【my computer】** , click **【property】** > **【device manager】** > **【port】**

If driver installation and connection is normal, it will show like below (device port number is COM44)

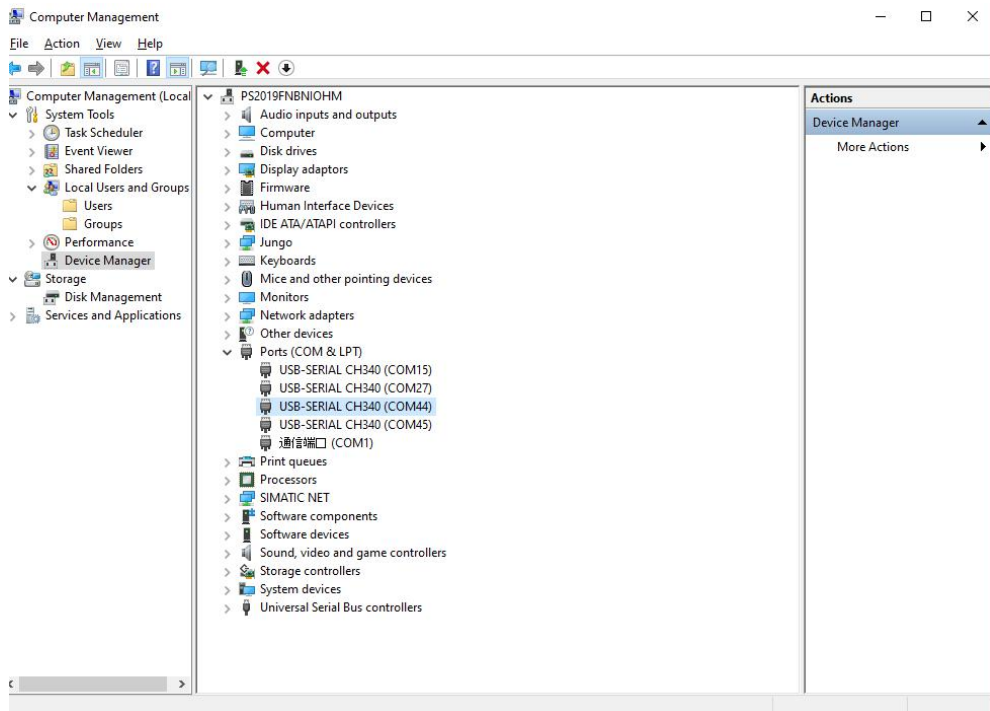

4.2 Login to Configuration Software

- ◆ Execute BL100 configuration software in PC, select the correct COM port (the port shown in device manager), and click confirm as below picture:

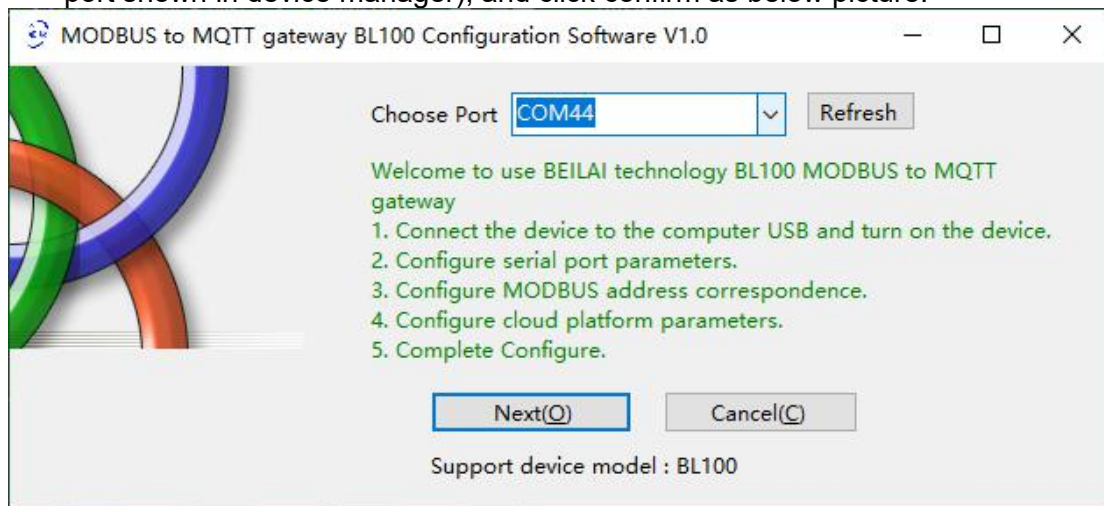

- ◆ Select SIM card type (M2M card or normal SIM card) and click enter configuration page

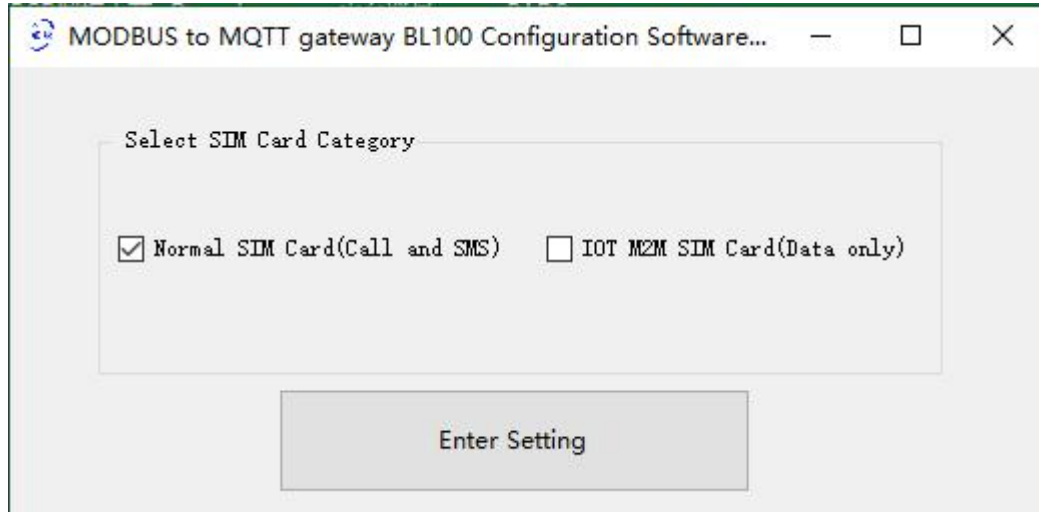

- ◆ Once it's logged in successfully, it will enter below page

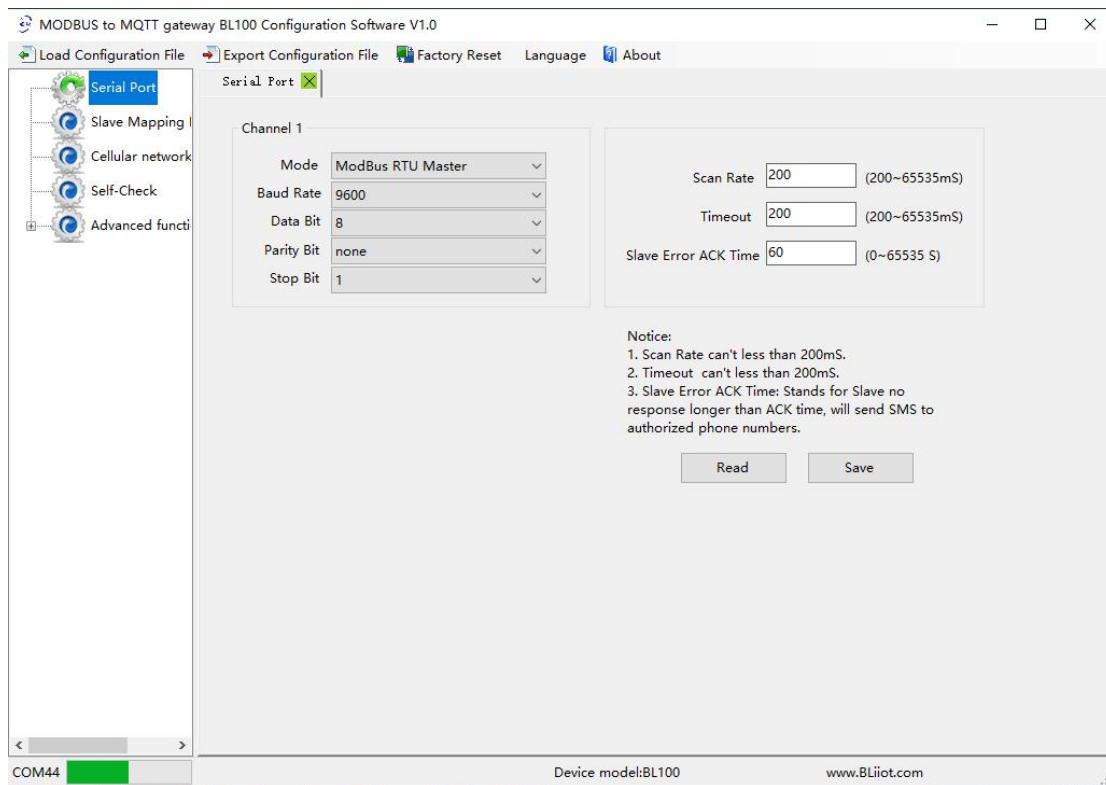

4.3 Serial Port Configuration

- ◆ This part includes RS485 serial port functions and parameters, including Modbus RTU Master, Modbus RTU Slave and Transparent Transmission.

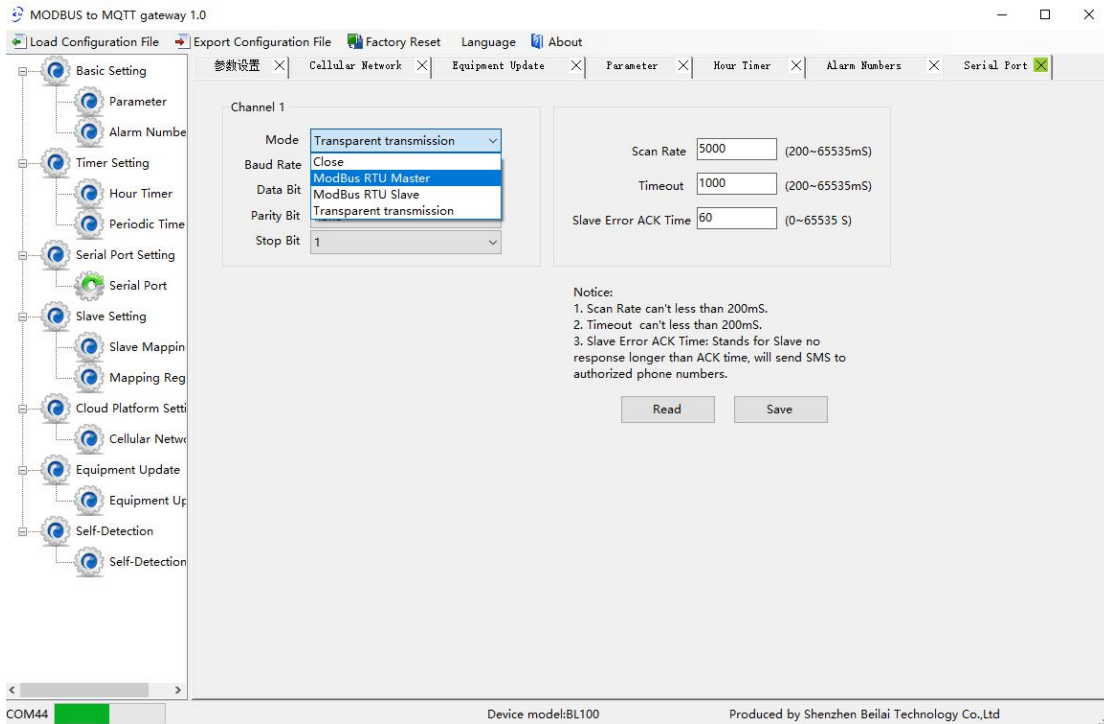

Note: "Poll Cycle", "Timeout", "Master and Slave Disconnection Acknowledgement Time" will only be valid when RS485 is used as Modbus RTU Master

Serial Port Configuration		
Item	Description	Default
RS485	Select from "disabled", "ModBus RTU Master", "ModBus RTU Slave" and "Transparent Transmission"	Disabled
Baud Rate	Select from 1200, 2400, 4800, 9600, 19200, 38400, 57600, 115200	9600
Data Bit	8	8
Parity Bit	Select from none, even, odd	none
Stop Bit	Select 1, 2	1
Polling Cycle	The time interval between 2 consecutive commands unit: ms	200
Timeout	Max time duration of waiting after Master sends command to slave (unit: ms). If waiting for more than the limit, then system will identify slave has no response data	200
Timeout Acknowledgement Time	If communication between master and slave fails, after the set time duration, system will send SMS alarm to user	60

4.4 Slave Mapping Table

Slave devices can be quickly added, modified and deleted. Please read mapped slave information once enter slave mapping table so that the new added slave will not replace the old slave. Select the slave and right click it to delete, add or modify parameters.

◆ Slave Mapping Table

Right click the box and click Add Slave to enter below page

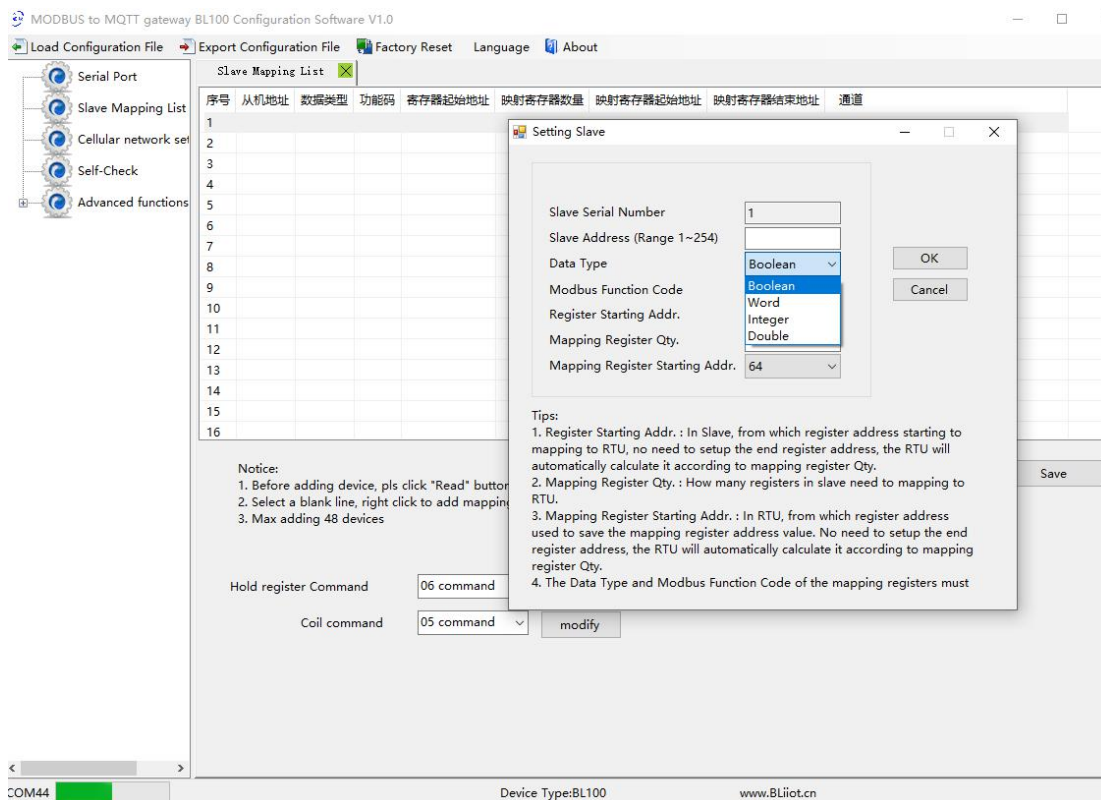

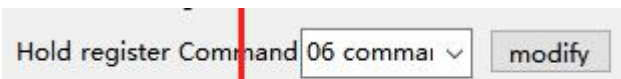
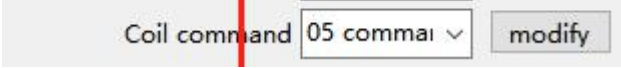
Add Slave@Slave Setting		
Item	Description	Default
No.	Item No.	--
Slave Address	Slave Device Address, range 1-247	Null
Register Type	Select from "Bool", "16-bit", "32-bit", "64-bit"	Bool
Function Code	Select from "01", "02", "03", "04", "15", "16"	Null
Slave Register Starting Address	Slave register starting address to be read and written	Null
Slave Qty to be Read	Qty of Slave to be read	Null
BL100 Mapping Register Starting Address	BL100 register starting address mapped by Slave register starting address	Null
BL100 Mapping Register Ending Address	BL100 register ending address is automatically calculated according to starting address and reading qty.	Null
Holding Register Control Function Code		Default 16
Coil Control Function Code		Default 15

Note: Usually it's OK to keep the default setting without any changes. If any devices can't support 05 15 or 06 16 function codes, then set the function code supported by the device

◆ Edit Slave

Select the slave and right click it to enter below operation window.

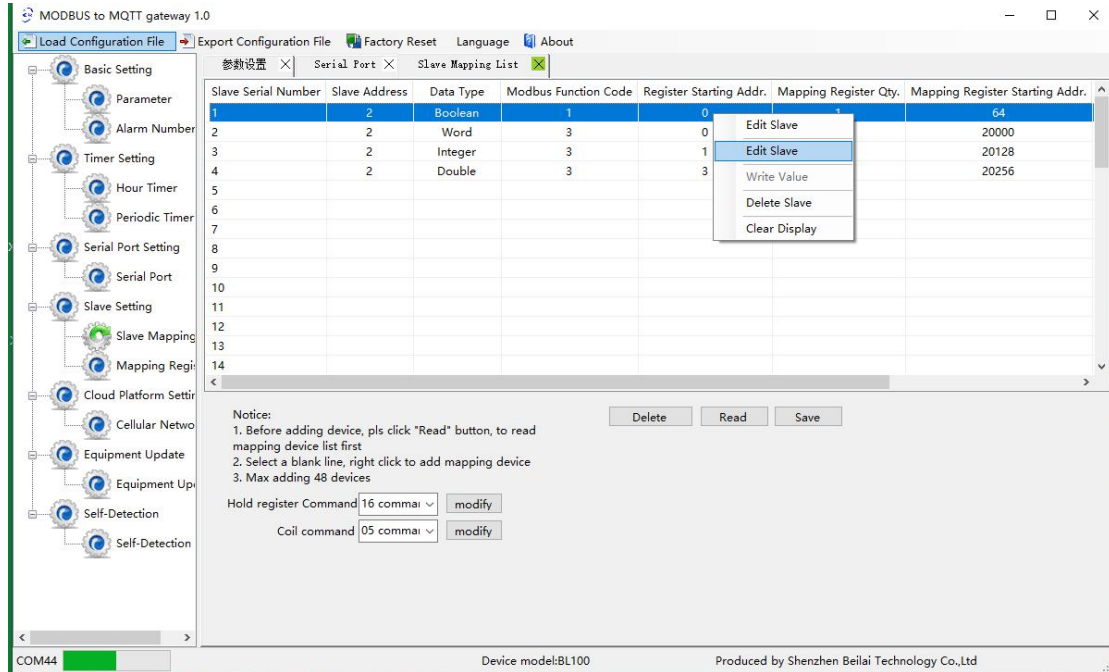

Click Edit Slave to enter below page

Boolean slave editing page:

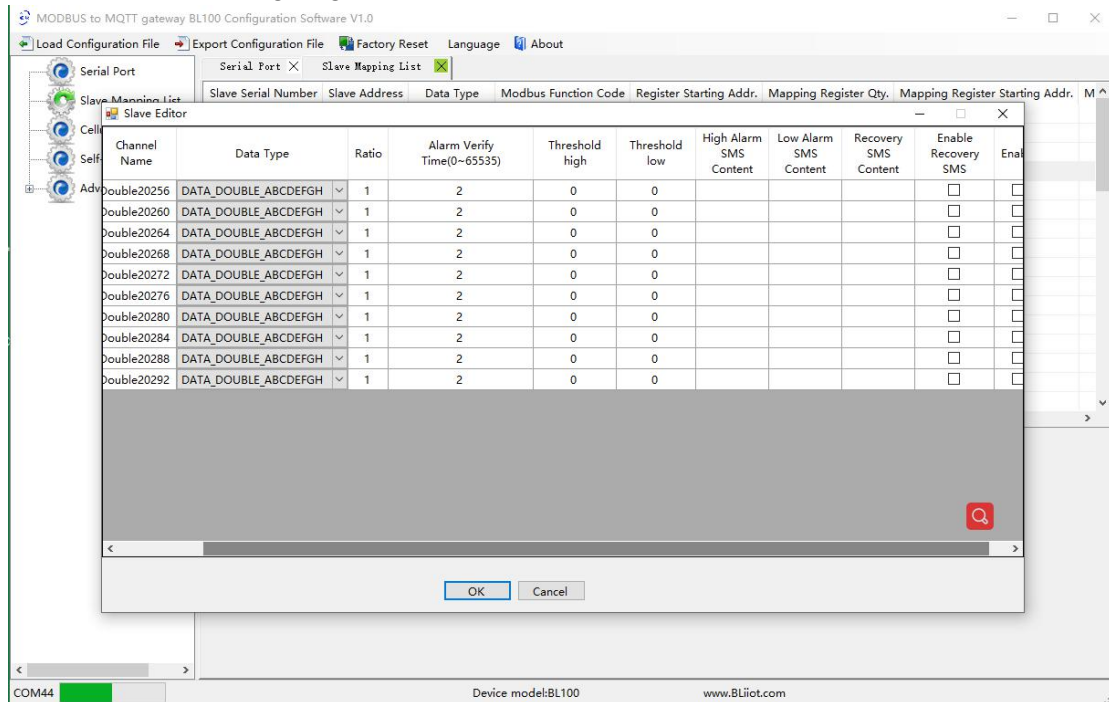

16-bit/32-bit/64-bit slave editing page:



Slave Editor

Address Mapping	Channel Name	Data Type	Ratio	Alarm Verify Time(0~65535)	Threshold high	Threshold low	High Alarm SMS Content	Low Alarm SMS Content	Recovery SMS Content	Ena Recc SN
20002	Int20002	DATA_SIGNED_AB	1	2	0	0				
20003	Int20003	DATA_SIGNED_AB	1	2	0	0				

OK Cancel

Slave Editor

Address Mapping	Channel Name	Data Type	Ratio	Alarm Verify Time(0~65535)	Threshold high	Threshold low	High Alarm SMS Content	Low Alarm SMS Content	Recovery SMS Content	Ena Recc SN
20128	DInt20128	DATA_LONG_ABCD	1	2	0	0				
20130	DInt20130	DATA_LONG_ABCD	1	2	0	0				
20132	DInt20132	DATA_LONG_ABCD	1	2	0	0				
20134	DInt20134	DATA_LONG_ABCD	1	2	0	0				

OK Cancel

Edit Slave@Slave Mapping Table		
Item	Description	Default
Mapping Address	BL100 mapping address corresponding to slave register address	--
Channel Name	Can be set, Once alarm is triggered, device will send SMS "channel name"+"alarm content". If alarm is recovered, device will send "channel name"+"alarm recovery content" to the authorized phone number. Enable Recovery SMS must be ticked in user number setting for receiving recovery SMS	--
Data Type	<ul style="list-style-type: none"> ● Boolean Can't be set. It's selected when adding Slave ● 16-bit/32-bit/64-bit Can be set according to slave datapoint type. ABCDEFGH represents slave register datapoint sequence 	Bool ABCDEF GH

Input Type (Boolean Slave)	<ul style="list-style-type: none"> ● NO: Normal Status is Open (0) ● NC: Normal Status is Closed (1) 	NO
Ratio (16-bit/32-bit/64-bit Slave)	The data in mapping address will multiply the ratio. Multiplied value will compare with high and low threshold. Once it's beyond the limit, alarm will be generated. Alarm content and current value will be sent to authorized user number. This ration only applies to cloud platform. It's not applicable for GPRS/3G/4G data collection	1
Alarm Verify Time	If abnormal data keeps for more than the verification time, device will send SMS to authorized number	2
Threshold High (16-bit/32-bit/64-bit Slave)	If mapping address data multiplies ration is higher than the threshold and alarm is enabled, device will send SMS "Channel name+high limit alarm content" to authorized numbers	Null
Threshold Low (16-bit/32-bit/64-bit Slave)	If mapping address data multiplies ration is lower than the threshold and alarm is enabled, device will send SMS "Channel name+low limit alarm content" to authorized numbers	Null
High Alarm SMS Content	If there's high limit alarm, send SMS "Channel name+high limit alarm content"	Null
Low Alarm SMS Content	If there's low limit alarm, send SMS "Channel name+low limit alarm content"	Null
Alarm SMS Content	If there's alarm, send SMS "Channel name+alarm content"	Null
Recovery SMS Content	If alarm is recovered, send SMS "Channel name+Recovery Content" to authorized numbers	Null
Enable Recovery SMS	It's ticked, alarm recovery SMS will be sent	Not ticked

Note: If SMS alarm is needed, it's necessary to tick Slave Alarm for authorized numbers in user number setting

4.5 Cloud Platform Connection Configuration

This page is used to configure device to connect to internet. Abundant automatic handshake package, custom heartbeat message and logout mechanism work together so that this device is compatible with many third-party cloud platforms and host computer system. Two-way communication between device and monitoring software or cloud platform is done through 4G cellular network

It supports below platforms:

- ◆ King Pigeon Cloud 3.0 login address: kpiiot.com
- ◆ King Pigeon Cloud 2.0 via Modbus login address: www.my-m2m.com
- ◆ King Pigeon Cloud 2.0 via MQTT login address: www.my-m2m.com
- ◆ HUAWEI IOT login address: www.huaweicloud.com
- ◆ Alibaba IOT login address: www.aliyun.com
- ◆ Other self-built platforms

4.5.1 King Pigeon Cloud 3.0

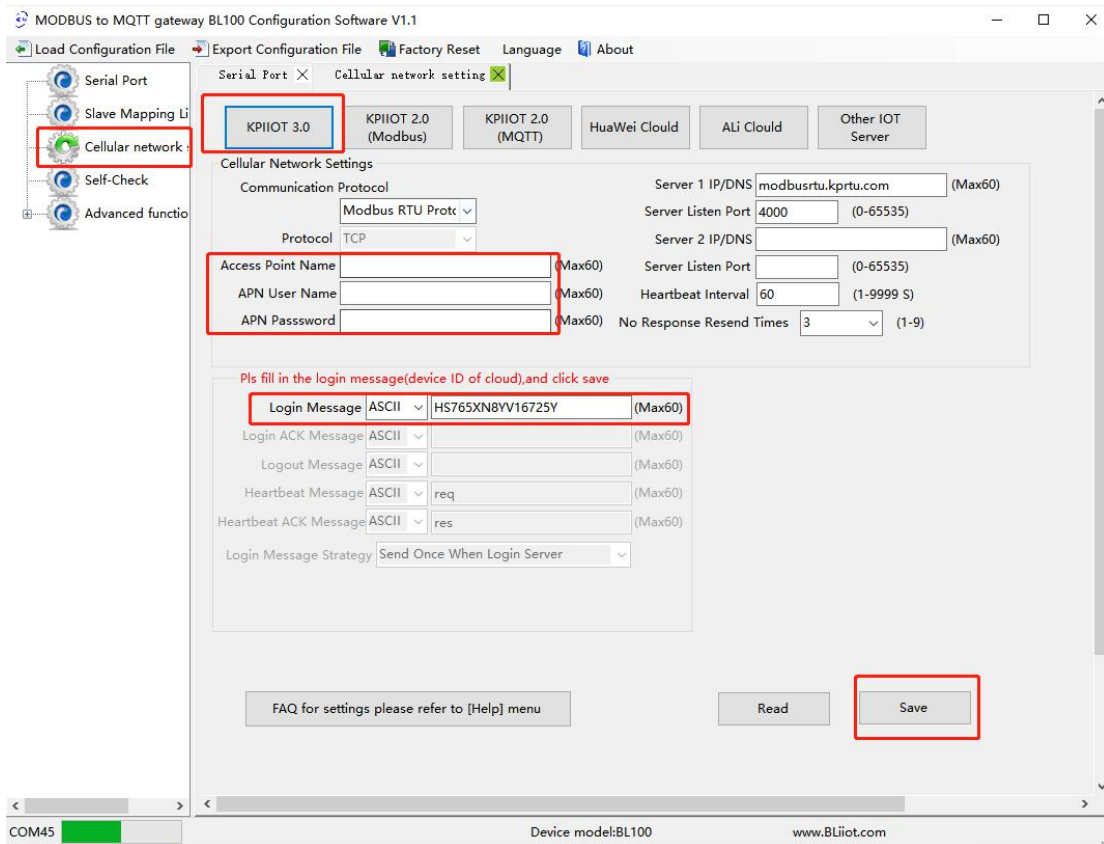

Note: Only Login Message needed to be entered for connecting King Pigeon cloud. Others keep the default settings

King Pigeon Cloud 3.0@Network Setting		
Item	Description	Default
Communication protocol	If King Pigeon Cloud 3.0 is selected, keep the default configuration software parameters	
Connection Mode	TCP	TCP
APN (Access Point Name)	Telecommunication service provider APN	Null
APN User Name	User name of APN to connect to network	Null
APN Password	Password of APN to connect to network	Null
Login Message	Unique device serial number (Contact King Pigeon sales team)	
Login ACK Message	default	Null
Logout Message	default	Null
Heartbeat Message	req	Default
Heart ACK Message	res	Default
Login Message Strategy	default	Send once to login
Server 1 IP/DNS	modbusrtu.kpiiot.com	Default
Server Listen Port	Target server 1 port number	4000
Server 2 IP/DNS	Target server 2 domain name or IP	Null
Server Listen Port	Target server 2 port number (0-65535)	Null

Heartbeat Interval	If connection to server fails for 3 times, it will reconnect after the set interval. Unit: second (1-9999) seconds	60
No Response Resend Times	If no response(login acknowledgement and heartbeat acknowledgement message is set) from server, data will be sent again for the set times (1-9)	3

4.5.2 King Pigeon Cloud 2.0 via Modbus

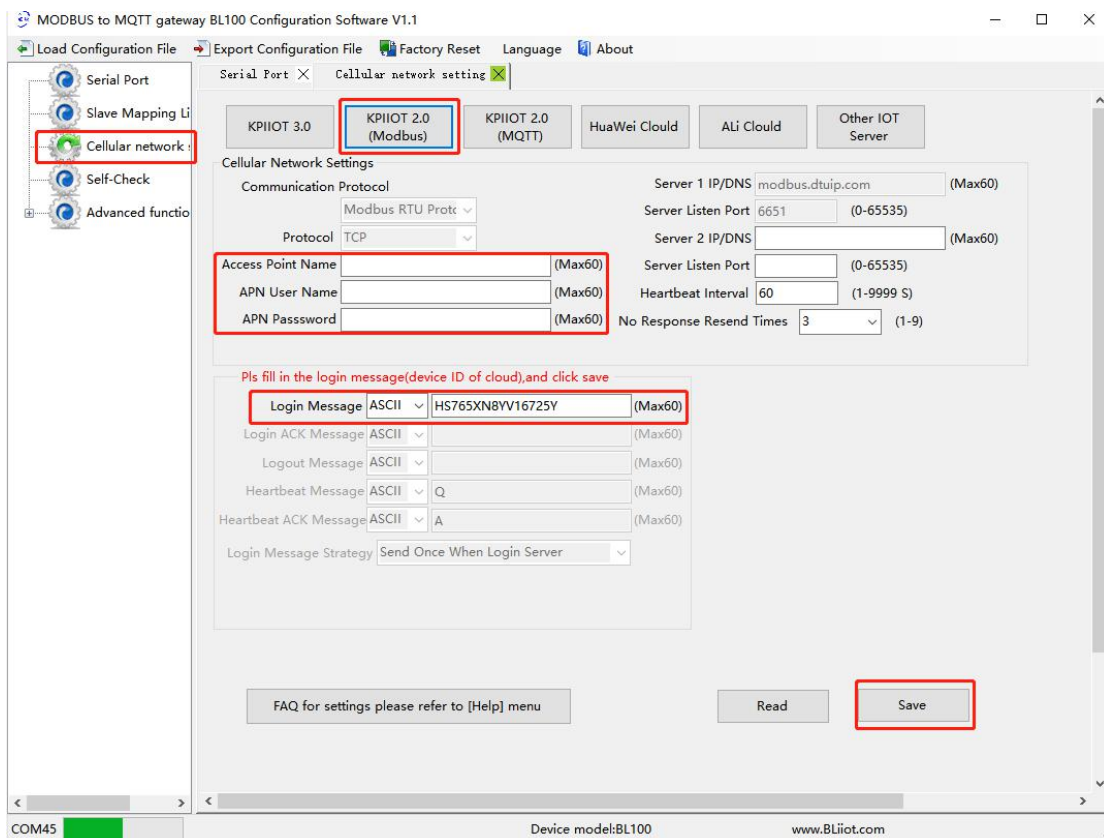

Note: Only Login Message needed to be entered. Others keep the default setting

King Pigeon Cloud 2.0 via Modbus@Network Setting		
Item	Description	Default
Communication Protocol	If King Pigeon Cloud 2.0 (Modbus) is selected, keep the default configuration software parameters	
Connection Mode	TCP	TCP
APN (Access Point Name)	Telecommunication service provider APN	Null
APN User Name	User name of APN to connect to network	Null
APN Password	Password of APN to connect to network	Null
Login Message	Unique device serial number (Contact King Pigeon sales team)	
Login ACK Message	Default	Null



Logout Message	Default	Null
Heartbeat Message	Q	Default
Heartbeat ACK Message	A	Default
Login Message Strategy	Default	Send once to login
Server 1 IP/DNS	modbus.dtuip.com	Default
Server Listen Port	Target server 1 port number	6651
Server 2 IP/DNS	Target server 2 domain name or IP	Null
Server Listen Port	Target server 2 port number (0-65535)	Null
Heartbeat Interval	If connection to server fails for 3 times, it will reconnect after the set interval. Unit: second (1-9999) seconds	60
No Response Resend Times	If no response(login acknowledgement and heartbeat acknowledgement message is set) from server, data will be sent again for the set times (1-9)	3

4.5.3 King Pigeon Cloud 2.0 via MQTT

Note: Only Login Message needed to be entered for connecting King Pigeon cloud. Others keep the default settings

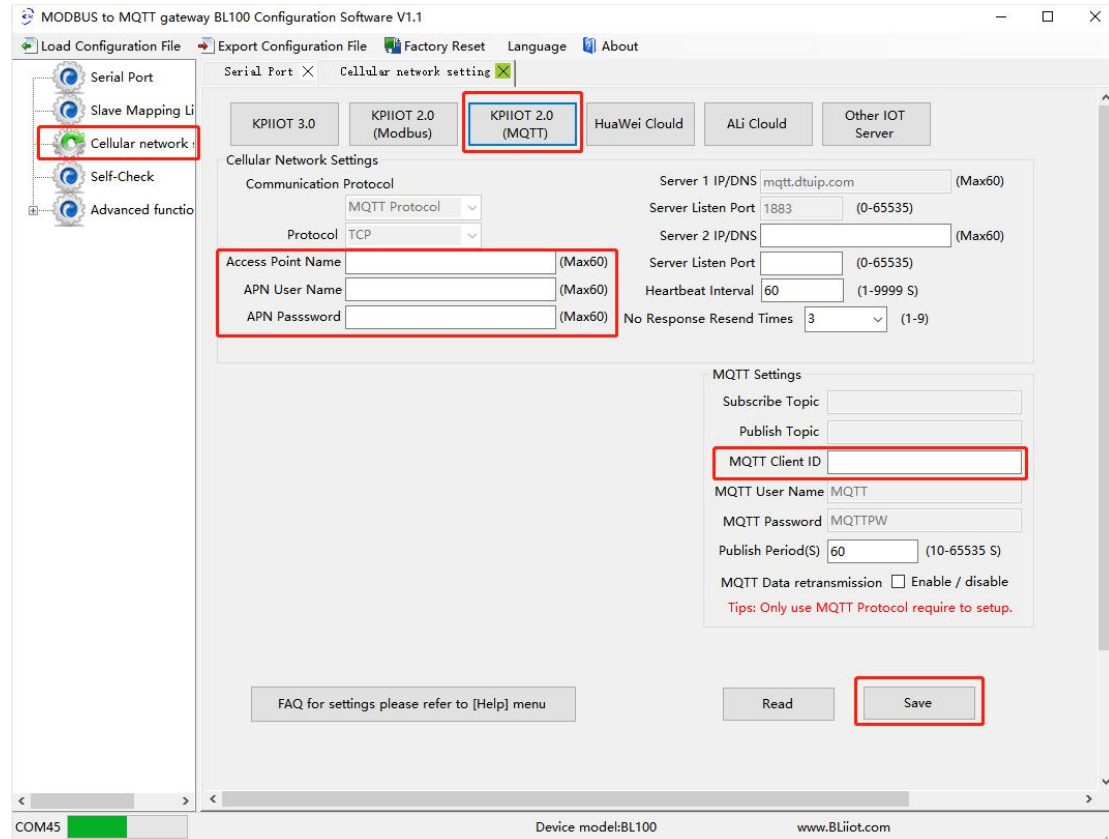

King Pigeon Cloud 2.0 via MQTT@Network Setting		
Item	Description	Default



APN (Access Point Name)	Telecommunication service provider APN	Null
APN User Name	User name of APN to connect to network	Null
APN Password	Password of APN to connect to network	Null
Server 1 IP/DNS	mqtt.dtuip.com	Default
Server Listen Port	Target Server 1 port number	1883
Server 2 IP/DNS	Target Server 2 domain name or IP	Null
Server Port Number	Target server 2 port number (0-65535)	Null
Heartbeat Interval	If connection to server fails for 3 times, it will reconnect after the set interval. Unit: second (1-9999) seconds	60
No Response Resend Times	If no response(login acknowledgement and heartbeat acknowledgement message is set) from server, data will be sent again for the set times (1-9)	3
Subscribe Topic	Topic of subscribing message/+	Automatically generated based on MQTT Client ID
Publish Topic	Topic of device publishing message	Automatically generated based on MQTT Client ID
MQTT Client ID	Unique device serial number (Contact King Pigeon Sales team)	
MQTT User Name	Account for device to publish topic in broker server	MQTT
MQTT Password	Password for device to publish topic in broker server	MQTTPW
Publish Period	Interval for device to upload data (10-65535) unit: second	10
MQTT Data Re-transmission	Tick it to enable offline data re-transmission once network resumes	Enable/Disable

4.5.4 HUAWEI Cloud Configuration

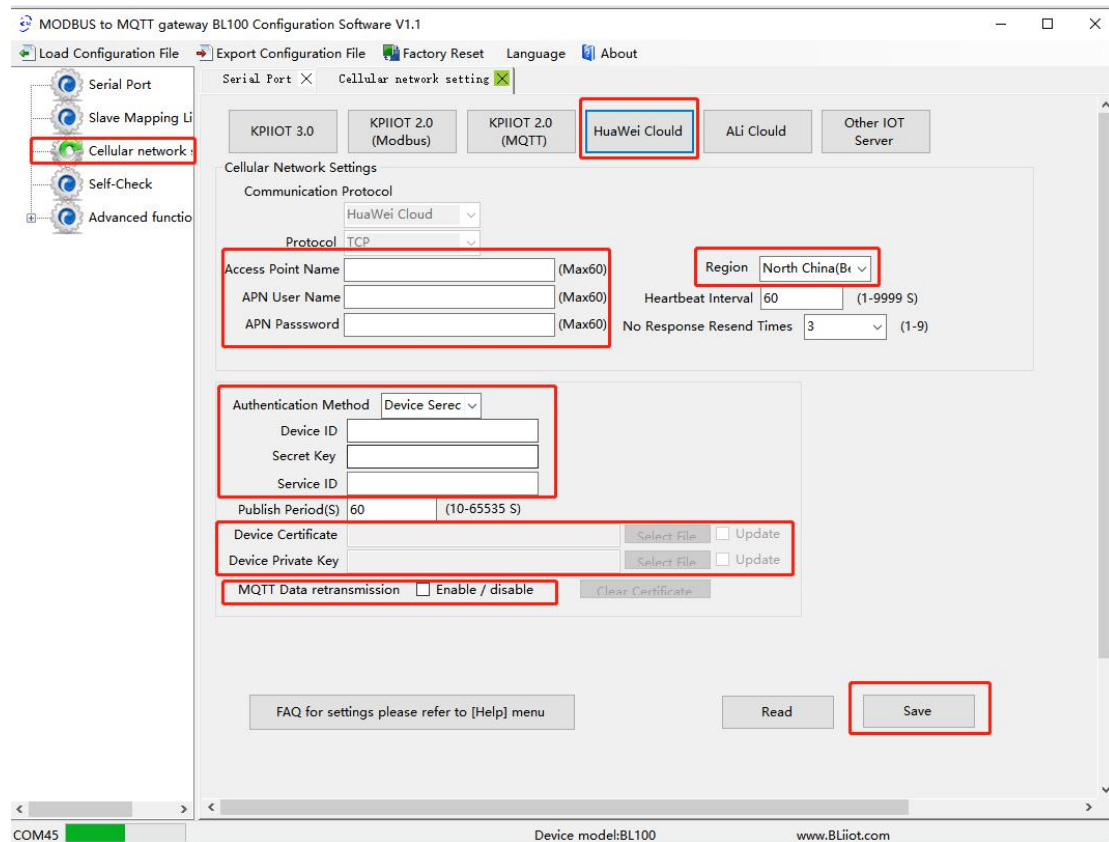

HUAWEI Cloud Configuration		
Item	Description	Default
APN (Access Point Name)	Telecommunication service provider APN	Null
APN User Name	User name of APN to connect to network	Null
APN Password	Password of APN to connect to network	Null
Authentication Method	Device Secret Key	Default
Device ID	Set the same device ID as that in HUAWEI Cloud (device-device ID)	Refer to 5.2.3 HUAWEI Cloud Application
Secret Key	Set the same secret key as that of HUAWEI Cloud when creating device. If it's lost, reset the password in device authentication method	
Service ID	Service ID created in HUAWEI Cloud	
Publish Period	Interval of publishing data, (10-65535) unit: second	60
MQTT Data Re-transmission	Tick it to enable offline data re-transmission once network resumes	Disable
Region	Select HUAWEI Cloud region. Default is North China Beijing 4	Default
Heartbeat Interval	If connection to server fails for 3 times, it will reconnect after the set interval. Unit: second	60

	(1-9999) seconds	
No Response Resend Times	If no response(login acknowledgement and heartbeat acknowledgement message is set) from server, data will be sent again for the set times (1-9)	3
X509 certificate	Can't support it currently	

4.5.5 Alibaba Cloud Configuration

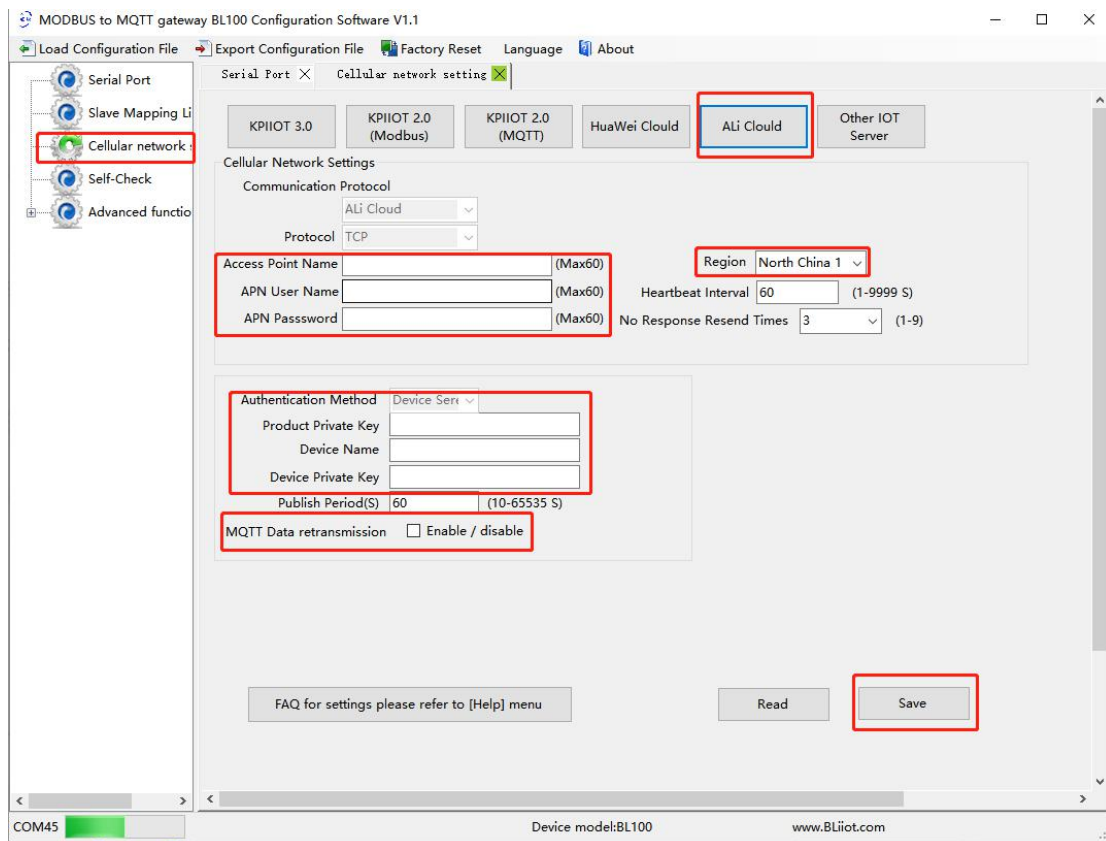

Alibaba Cloud Configuration		
Item	Description	Default
APN (Access Point Name)	Telecommunication service provider APN	Null
APN User Name	User name of APN to connect to network	Null
APN Password	Password of APN to connect to network	Null
Authentication Method	Device Secret Key	Default
Product Private Key	Set the same ProductKey as Alibaba cloud (Device—click Device Secret to view it)	Refer to 5.2.4 Alibaba Cloud Application
Device Name	Set the same DeviceName as Alibaba Cloud (Device—Click DeviceSecret to view it)	
Device Private Key	Set the same DeviceSecret as Alibaba Cloud. (Device—Click DeviceSecret to view it)	
Publish Period	Interval of publishing data, (10-65535)	60

	Unit: second	
MQTT Data Re-transmission	Tick it to enable offline data re-transmission once network resumes	Disable
Region	Select Alibaba Cloud region. Default is East China 2 (Shanghai)	Default
Heartbeat Interval	If connection to server fails for 3 times, it will reconnect after the set interval. Unit: second (1-9999) seconds	60
No Response Resend Times	If no response(login acknowledgement and heartbeat acknowledgement message is set) from server, data will be sent again for the set times (1-9)	3

4.5.6 Other IOT Server (Custom Protocol)

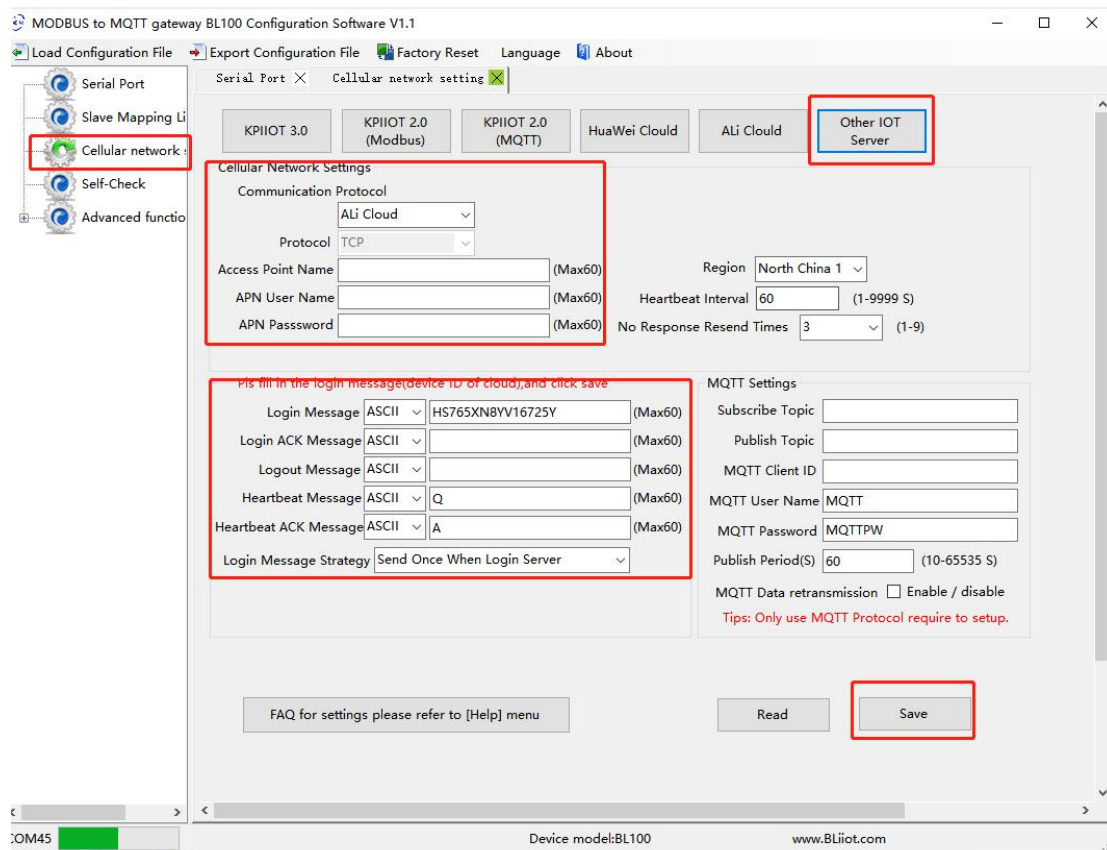

Custom Protocol Configuration	
Communication Protocol	Select according to user requirement
Server IP/ Domain Name	User-defined

Server Listen Port	User-defined
Login Message	User-defined
Login ACK Message	User-defined (server response to login message)
Heartbeat Message	User-defined (heartbeat message to keep connection)
Heartbeat ACK Message	User-defined (Server response to heartbeat message)
Heartbeat Interval	Interval of sending heartbeat message, default is 60s
Login Message Strategy	User-defined

Note: Users set the parameters based on custom protocols and actual requirements.
 Note: Custom MQTT protocol data format is the same as King Pigeon Cloud 2.0 MQTT data format. Refer to [5.2.5 MQTT Application](#). Modbus RTU and Modbus TCP are standard Modbus protocol. Refer to [Appendix 6.3, 6.4 and 6.5](#) for message details

4.6 Device Self-Checking

- ◆ BL100 supports self-checking before configuration

Below page shows self-checking is completed

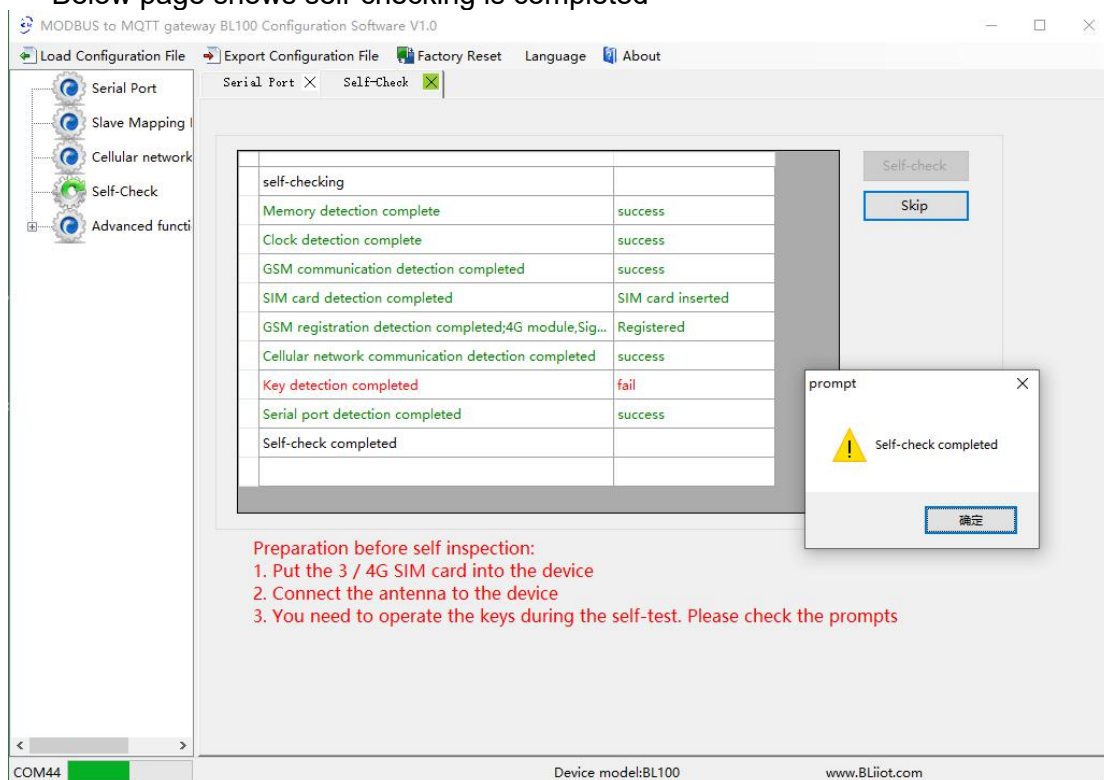

self-checking	
Memory detection complete	success
Clock detection complete	success
GSM communication detection completed	success
SIM card detection completed	SIM card inserted
GSM registration detection completed;4G module,Sig...	Registered
Cellular network communication detection completed	success
Key detection completed	fail
Serial port detection completed	success
Self-check completed	

Preparation before self inspection:
 1. Put the 3 / 4G SIM card into the device
 2. Connect the antenna to the device
 3. You need to operate the keys during the self-test. Please check the prompts

Note: Insert SIM card, connect antenna properly and manually press self-check button to trigger it.

4.7 Advanced Functions

4.7.1 Parameter Configuration

In this section, users can quickly read and configure device basic information, including model, version, device time, device ID and description.

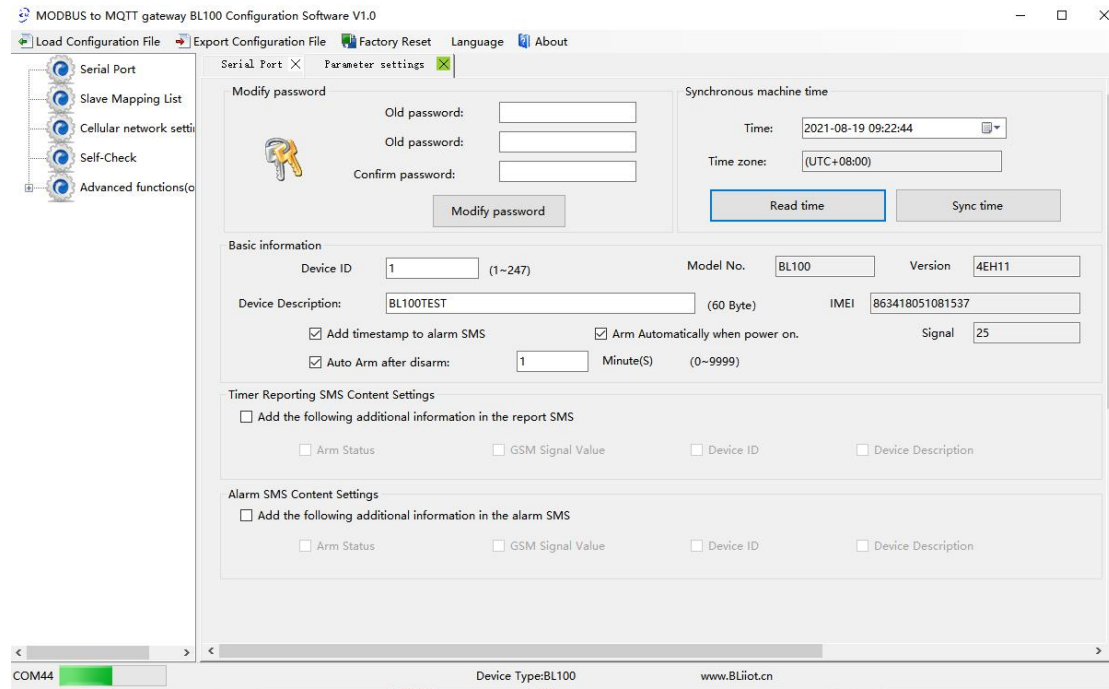

Sync Device Time@Basic Information		
Item	Description	Default
Time	Display/select device current time	--
Read Time	Click it to read RTU time	--
Sync Time	Click it to sync computer time to RTU	--
Signal	Display device signal strength, range 0-31	Automatic
General Operation@Basic Information		
Item	Description	Default
Device ID	Used as device ID address in ModBus protocol, range 1-247	1
Model Number	Automatically read device model number	--
Version	Automatically read device version	--
Device Description	If device description is set, it will be included in alarm SMS	Null
Add timestamp to alarm SMS	If ticked, SMS alarm content will include timestamp	Tick
Arm automatically when power on	If ticked, it will automatically be armed once powered on. Only in armed status alarm event will happen if it's triggered	Tick
Auto Arm after Disarm Set interval:	Once device is disarmed, it will be armed automatically after the set interval	Not Ticked
Timer Reporting @Basic Information		

Item	Description	Default
Add the following additional information in the report SMS	If following items are ticked and SMS reporting is set in timer, SMS will be sent to authorized number. To get regular SMS reporting, need to set SMS reporting in Timer, tick this item and set user number	Not ticked
Alarm SMS Setting@Basic Information		
Item	Description	Default
Add the following additional information in the alarm SMS	If following items are ticked, the status will be included in the SMS if there's any alarm and sent to authorized user number	Not ticked

4.7.2 User Number Setting

◆ This page is introduction to setting user number and access control

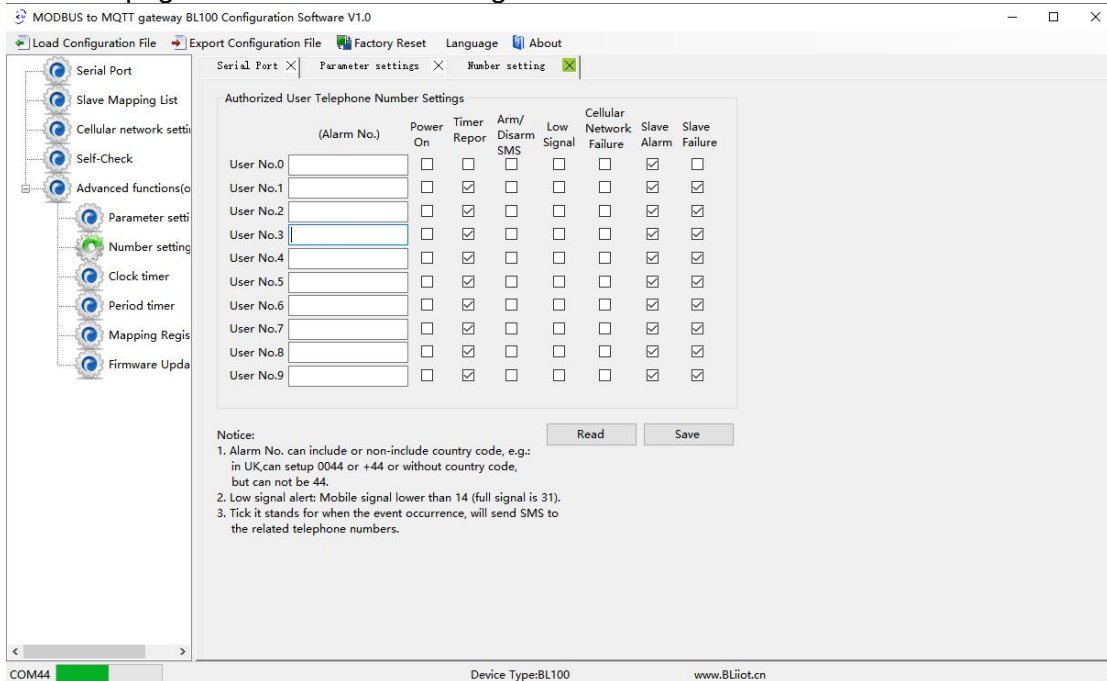

Note: For alarm SMS, please select according to actual requirement

User Number Setting		
Item	Description	Default
User No.	Total 10 user numbers can be set to receive SMS	Null
Power On	If it's ticked, SMS will be sent to user number, including device model, version, description, IMEI, status, cellular network signal value, etc once device is powered on	Ticked
Timer Report	If it's ticked, SMS will be sent to user number as scheduled reporting cycle	Ticked
Arm/Disarm SMS	If it's ticked, SMS will be sent to user number if device arm/disarm status changes	Ticked
Low Signal	If it's ticked, SMS will be sent to user number once cellular network signal value is less than 14	Not ticked
Cellular Network Failure	If it's ticked, SMS will be sent to user number once connecting to server fails for 3 times	Not ticked

Slave Alarm	If it's ticked, RS485 interface slave alarm will be sent to user number	Not ticked
Slave Communication Failure	If it's ticked, SMS will be sent to user number once the communication with RS485 interface slave timeout	Not ticked

Note: If alarm SMS is needed, please tick Slave Alarm in Number Setting

4.7.3 Timer

In this page, users can quickly set device to perform certain actions in scheduled time to realize automatic control devices. Labor cost can be largely saved. Total 10 events can be set based on weekly, daily or certain time interval

4.7.3.1 Clock Timer

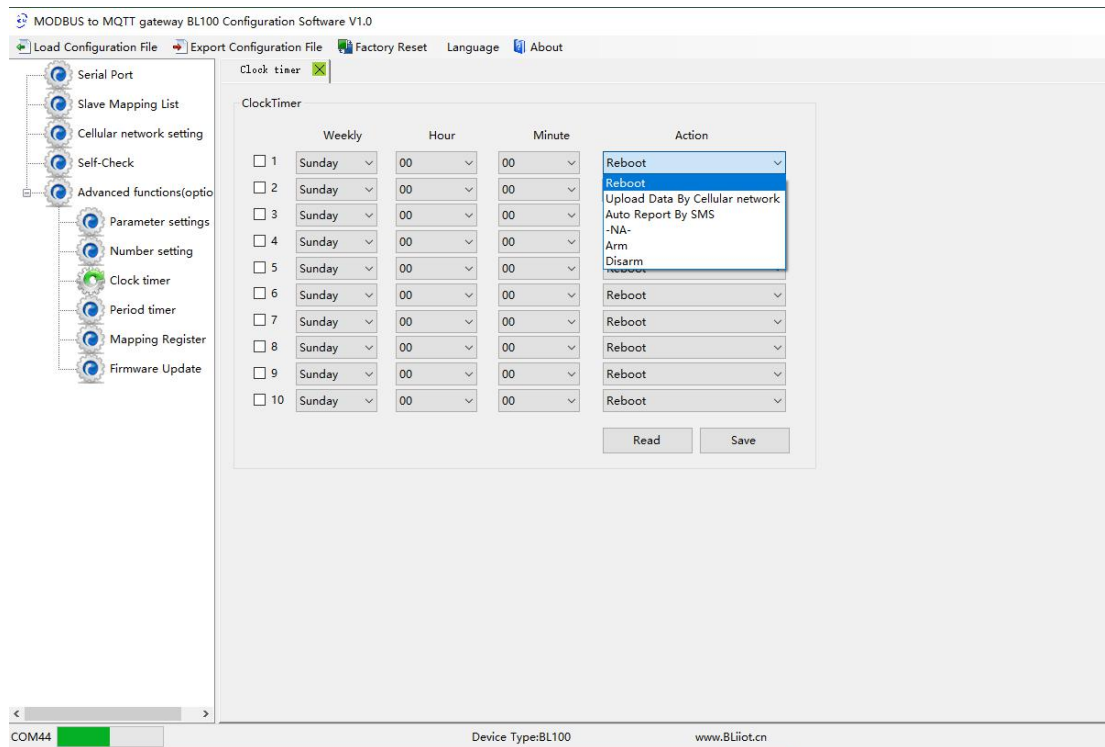

Clock Timer		
Item	Description	Default
1-10	Refers to 1-10 Timer	Not ticked
Weekly	Set any day of the week or every day	--
Hour	Set specific hour	--
Minute	Set specific minute	--
Action	Action to be performed once at certain time. Select from "restart", "uploading cellular network data", "Auto Report by SMS", "Arm", "Disarm"	--

4.7.3.2 Period Timer

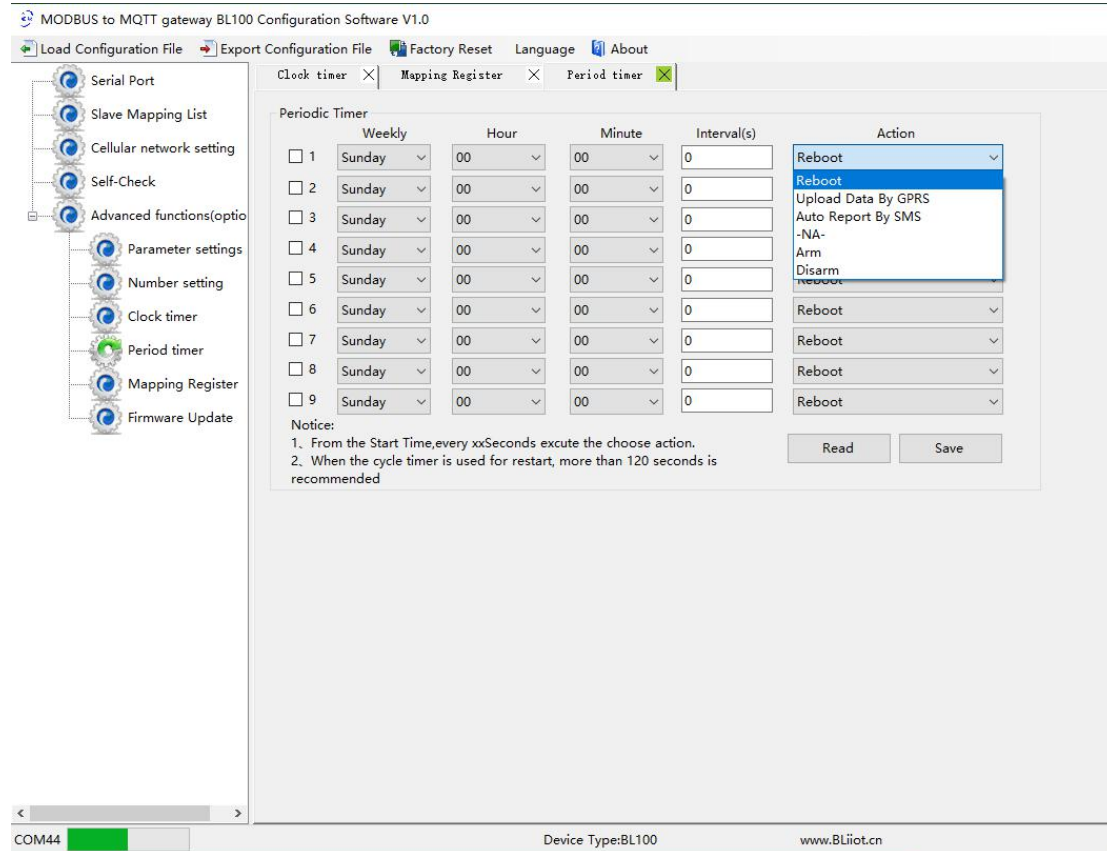

Period Timer		
Item	Description	Default
1-10	Refers to 1-10 Timer	Not ticked
Weekly	Set any day of the week or every day	--
Hour	Set specific hour	--
Minute	Set specific minute	--
Action	Action to be performed once at certain time. Select from "restart", "uploading cellular network data", "Auto Report by SMS", "Arm", "Disarm"	--

4.7.4 Device Firmware Update

BL100 support online firmware update. Click Select to import program file and click Update. Once firmware update is 100% completed, restart the device

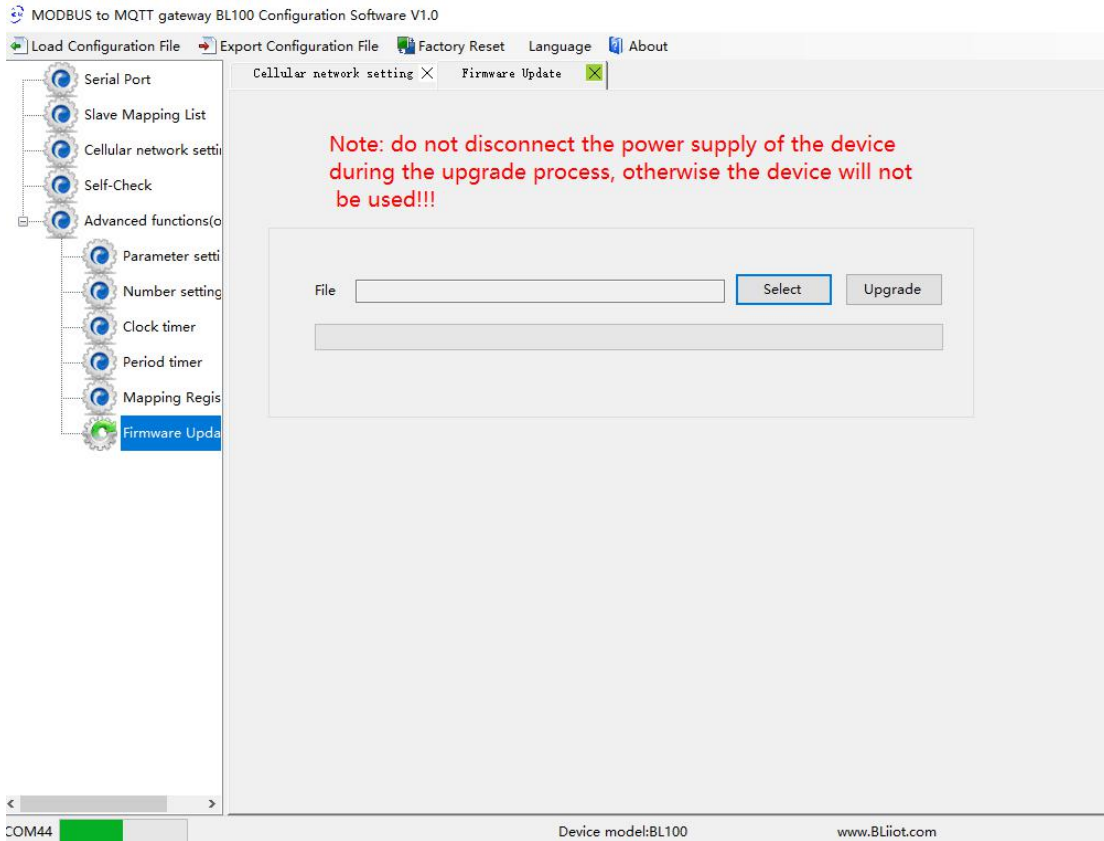

4.7.5 Mapping Register Data

Click **【Mapping Register Data】** to view slave device real-time value so that users can debug and install devices easily.

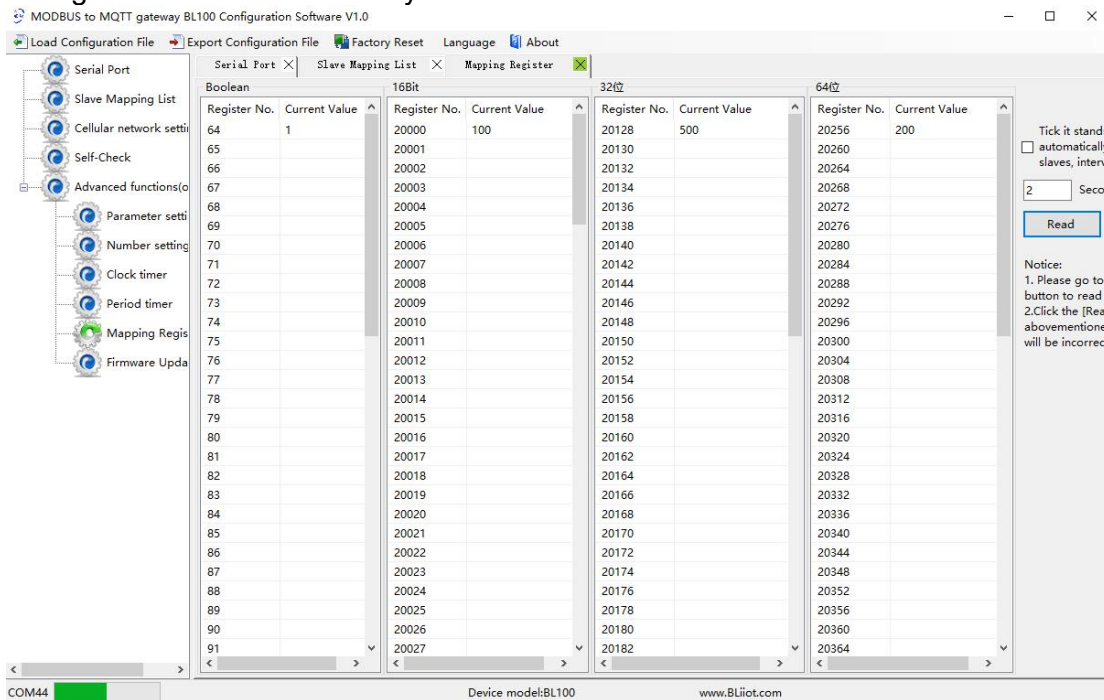

Note: To read slave device data, click Read in Slave Mapping List first and then view it in Mapping Register Data

4.8 Export Configuration File

- ◆ Click top left button Export Configuration File, select file saving path and enter file name

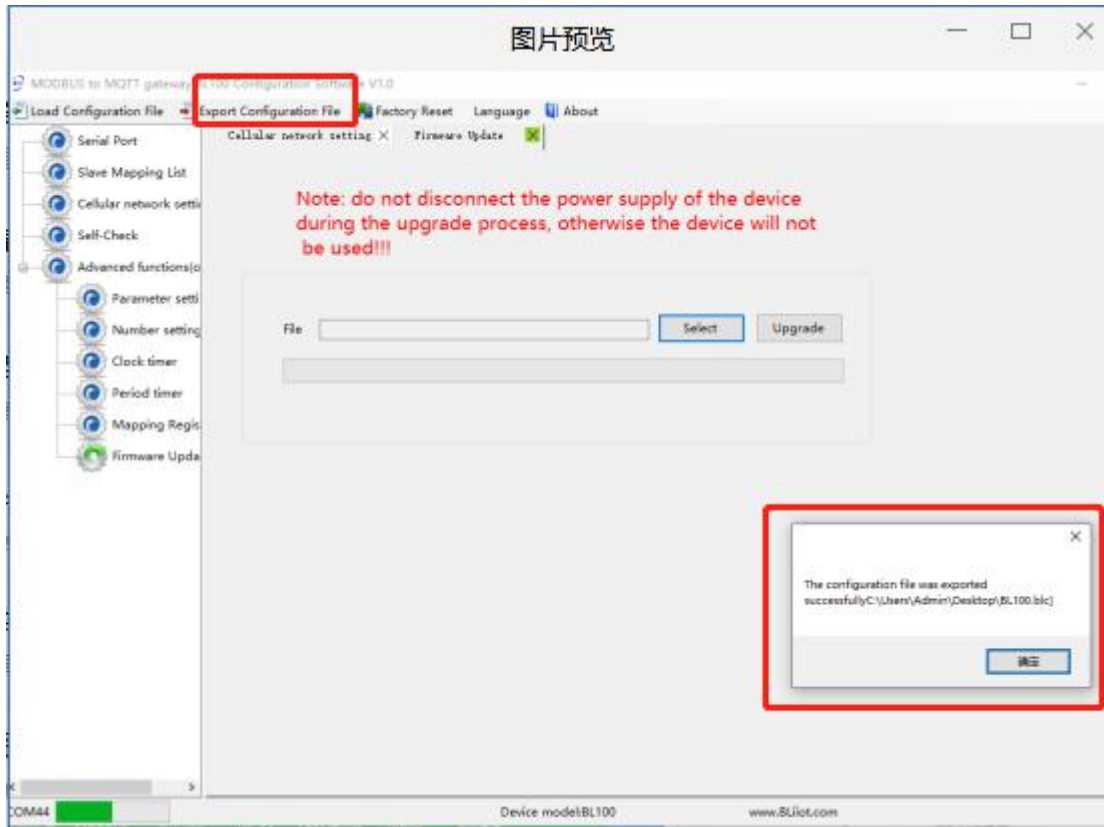

- ◆ After a while, configuration exporting success window will pop out

4.9 Load Configuration File

- ◆ Click top left button Load Configuration File and select the file to upload it.

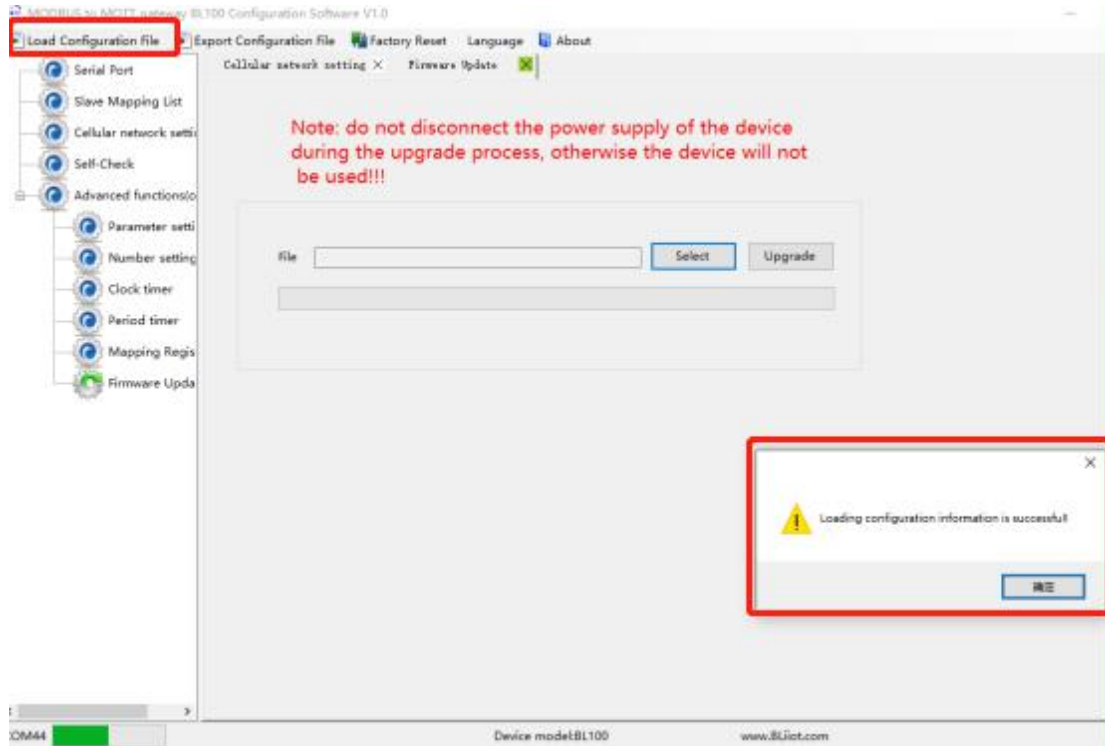

- ◆ After a while, loading configuration success window will pop up

4.10 Factory Reset

- ◆ Once device is powered on, connect it with PC configuration software and click Factory Reset. After factory resetting notice box pops out, click confirm to complete it.

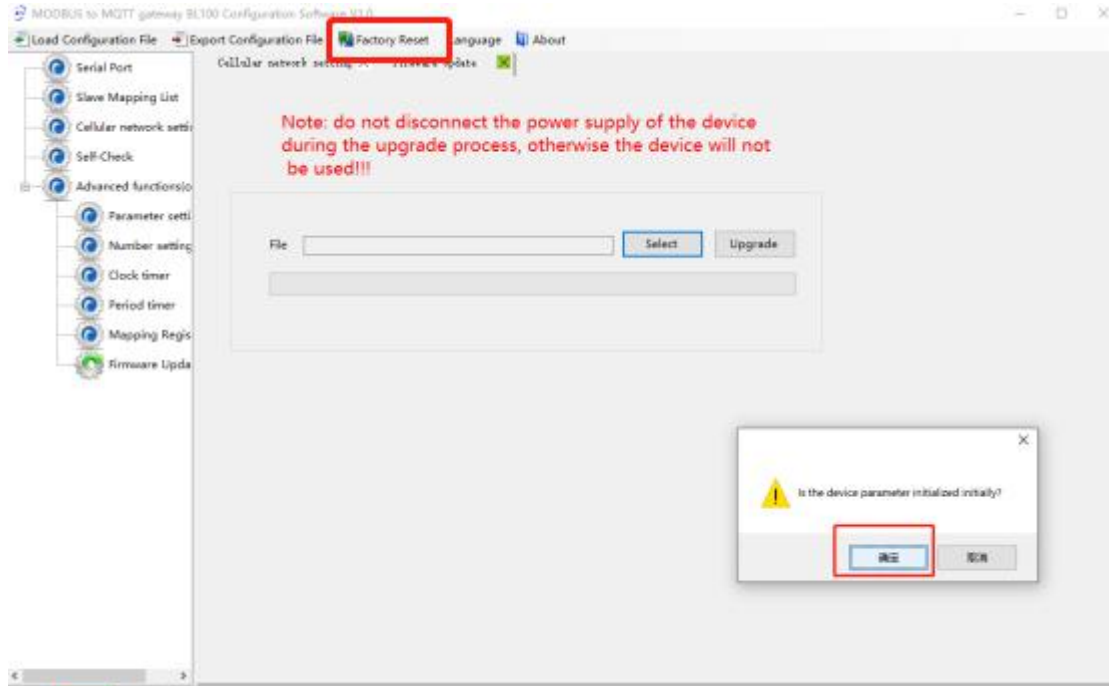

5 Device Application and Cloud Connection Example

5.1 Transparent Transmission (DTU) Setting

BL100 has DTU function of transparent data transmission. Data sent to BL100 from server or cloud platform via cellular network will be forwarded to RS485 interface. Data received from BL100 RS485 interface will be sent to server or cloud platform via cellular network. Detailed operation procedures are as below:

- (1) In Parameter Setting Page, set device ID

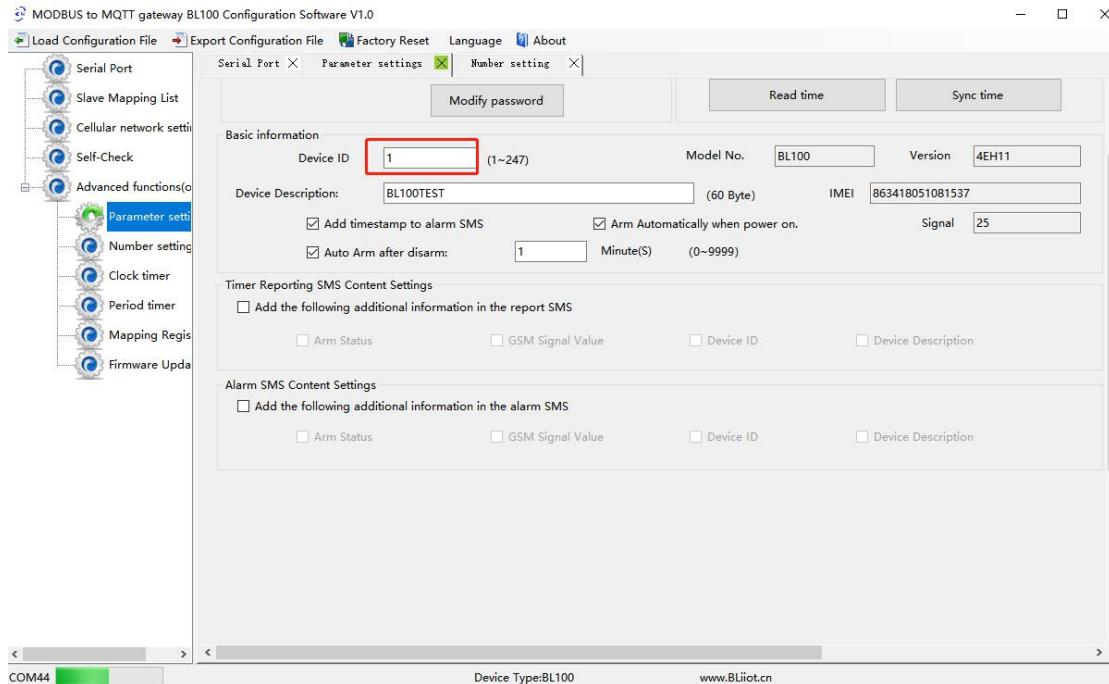

Note: Device connected to RS485 interface can not have the same ID as BL100 ID

(2) In Serial Port setting, select Transparent Transmission as RS485 mode. Baud rate, data bit, parity bit and stop bit must be the same as those of RS485 interface device parameters. Otherwise the communication will not be successful

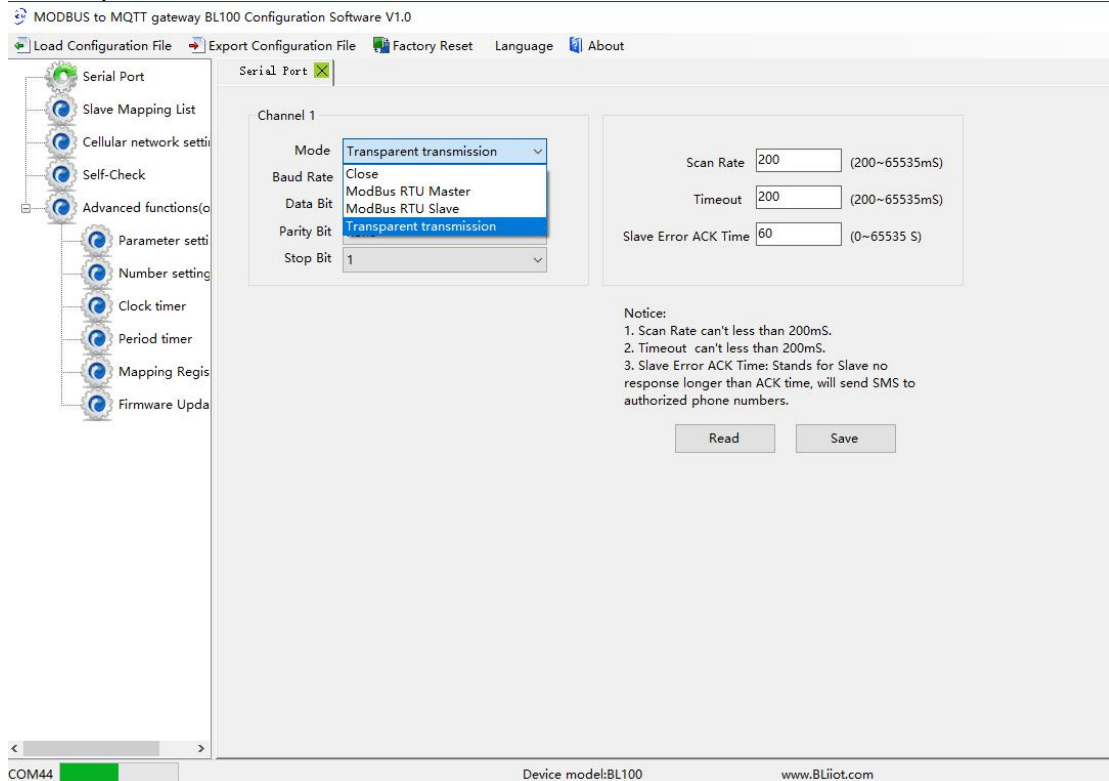

If there are multiple devices connected to RS485 interface, their parameters must be the same as BL100 parameters. For scan rate, timeout and Slave Error ACK Time, it's OK to keep the default setting.

- (3) Click below Save button
- (4) In configuration software, set cloud communication protocol to Modbus RTU. Other settings refer to [4.5.6 Other IOT Platform](#)

5.2 Modbus Master and Cloud Connection

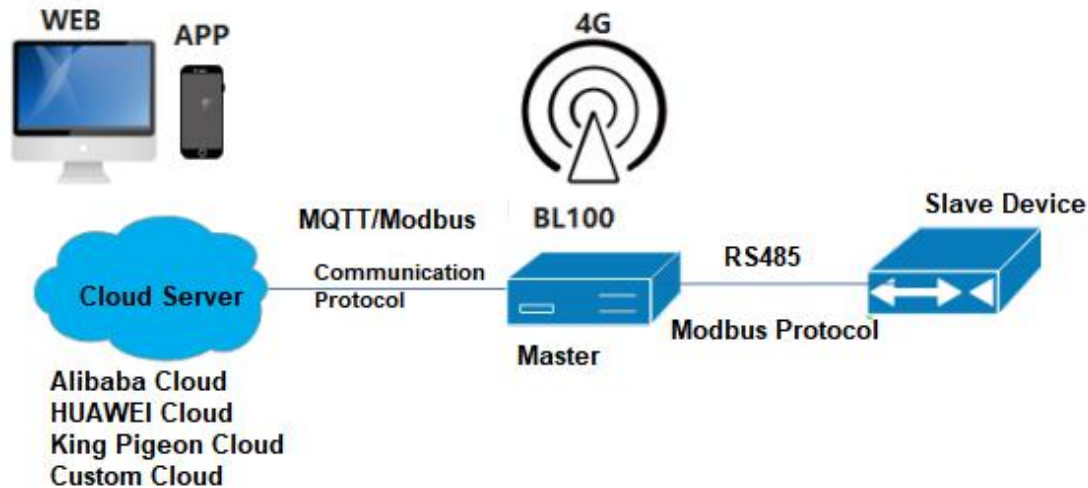

BL100 can be connected to cloud platform or SCADA system via cellular network. Users can choose custom platform, King Pigeon Cloud 2.0, King Pigeon Cloud 3.0, Alibaba Cloud and HUAWEI Cloud.

If connecting it to King Pigeon Cloud, just click the selected platform in cellular network setting and enter Login Message (device serial number) provided by King Pigeon sales team. For other part, keep the default settings. Click Save to complete configuration easily.

Users can connect the device to private cloud via Modbus RTU, Modbus TCP and MQTT protocols. Refer to [5.2.5 MQTT Application](#) for MQTT details

Cloud Connection Procedure:

(Step 1 & 2 are common and will not be repeated. Only Step 3 & 4 are different for different platforms.)

Step 1 Set serial port as Modbus Master in Configuration Software

Step 2 Set Slave Device Datapoint in Configuration Software

Step 3 Set Cloud Parameters in Configuration Software

Step 4 Set Device Datapoint in Cloud Platform

5.2.1 RS485 Serial Port Mode Setting

(1) Set serial port mode to Modbus RTU Master

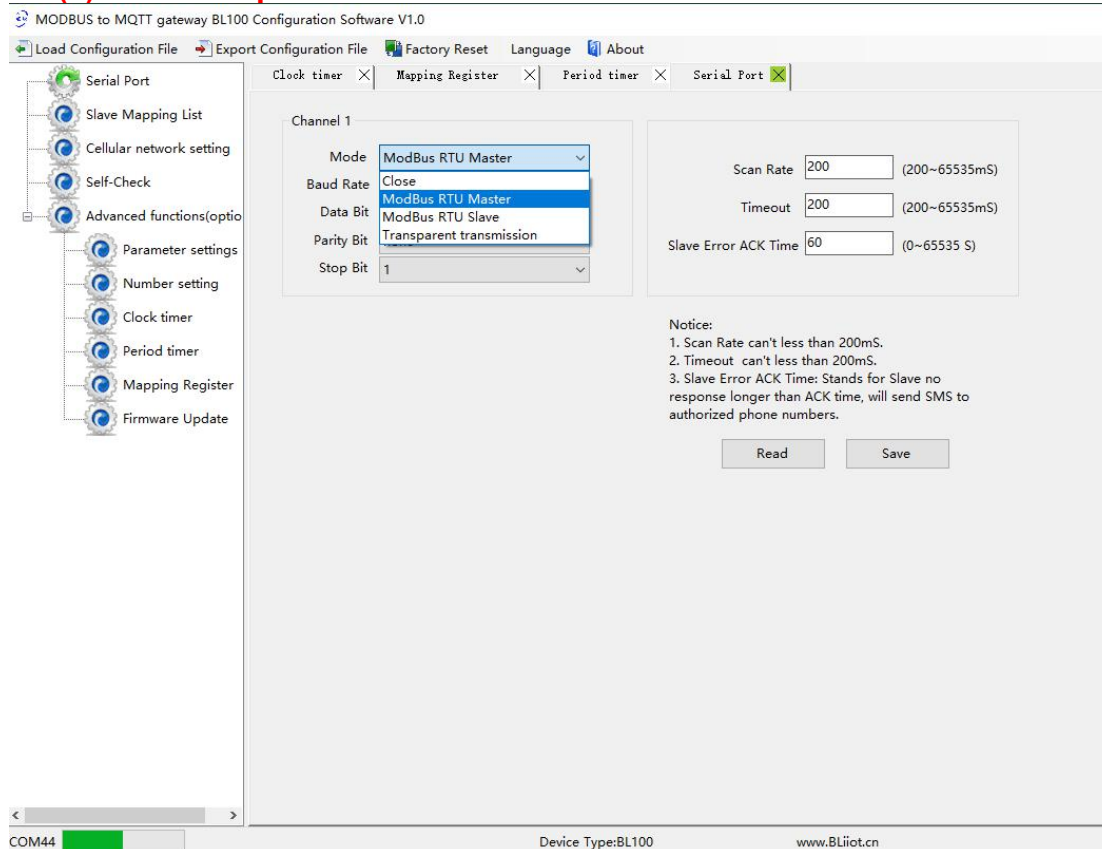

(2) Set Slave Datapoint

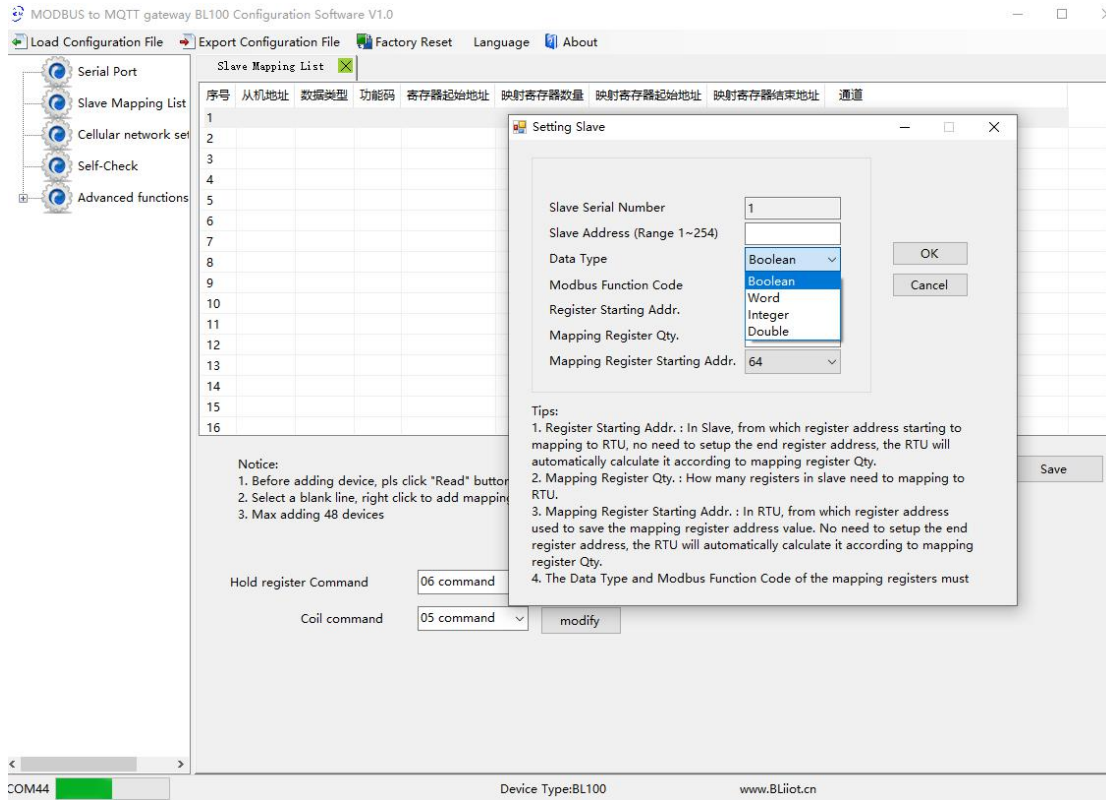

◆ Edit slave parameters:

Right click slave data type to enter setting page. High limit alarm, low limit alarm, alarm SMS content and recovery SMS content can be set. Tick Alarm SMS to enable it.

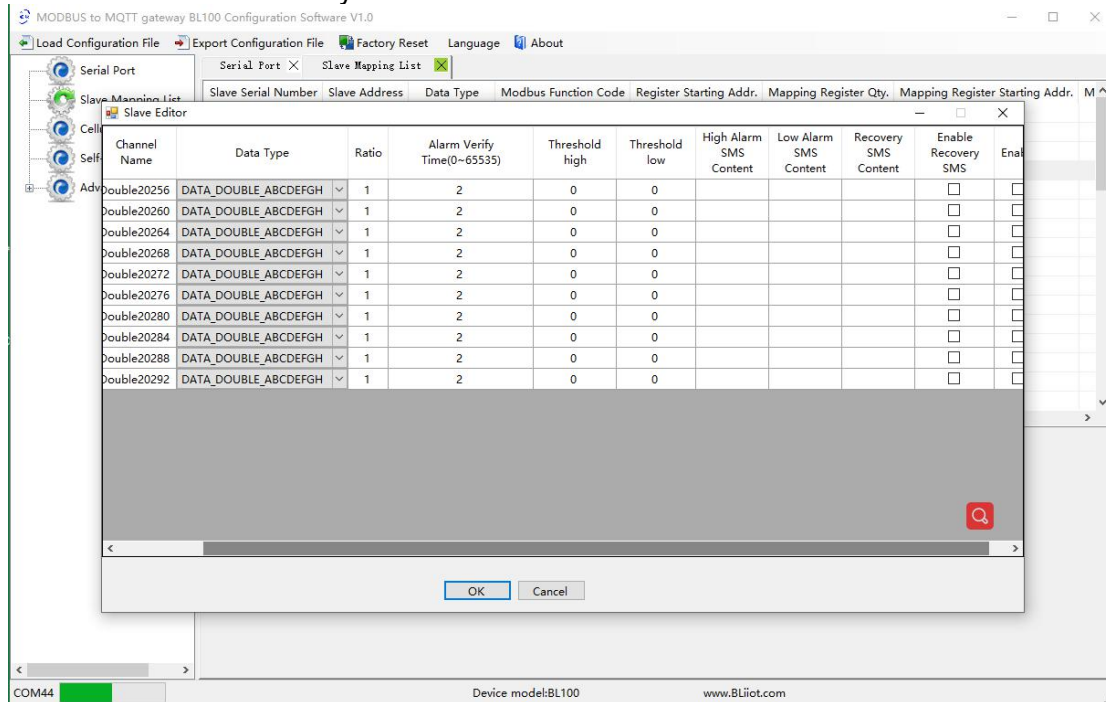

◆ Once datapoint is set, click mapping register to read datapoint real-time value. Configuration before cloud connection is completed. The following procedure is to configure cloud connection.

5.2.2 King Pigeon Cloud Application

(3) Set Cloud Connection Parameter

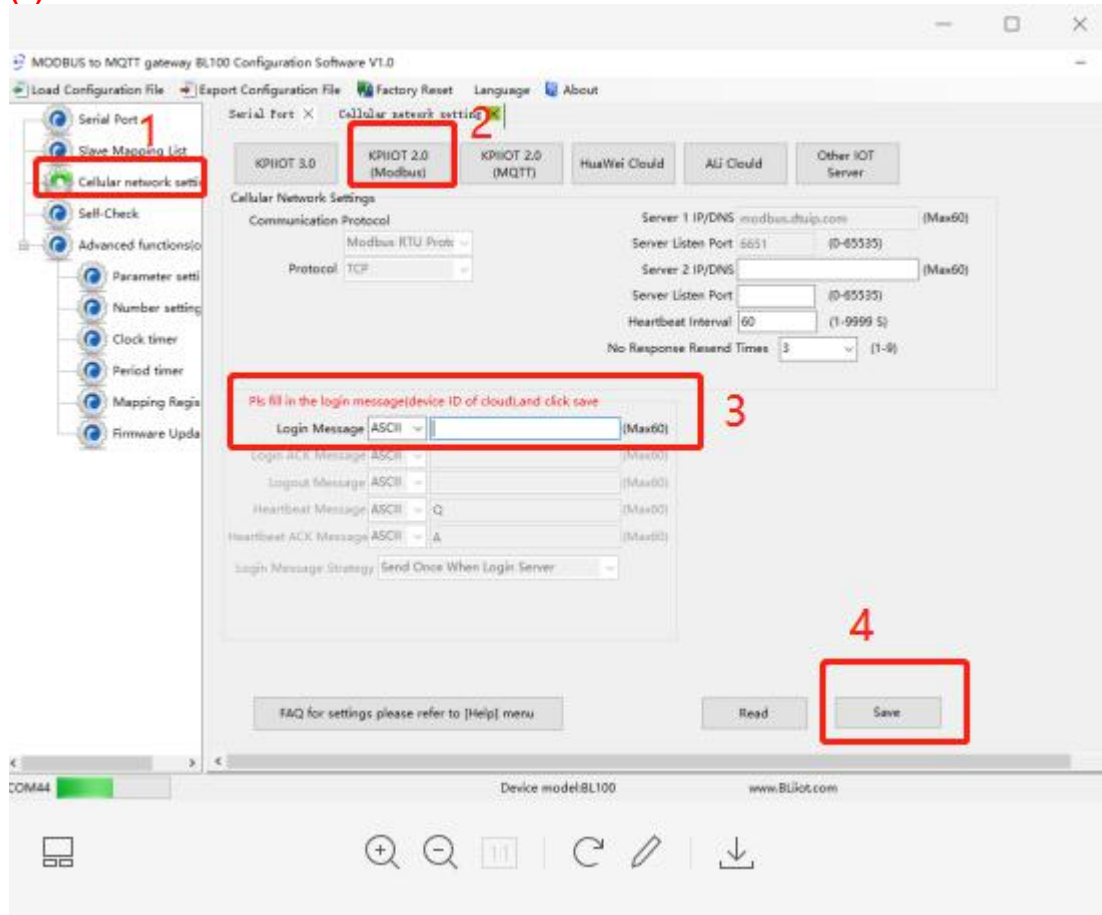

(4) Set Device Datapoint in Cloud Platform (for datapoint mark REGXXX details, please refer to Appendix 6.2 Mapping Register Address)

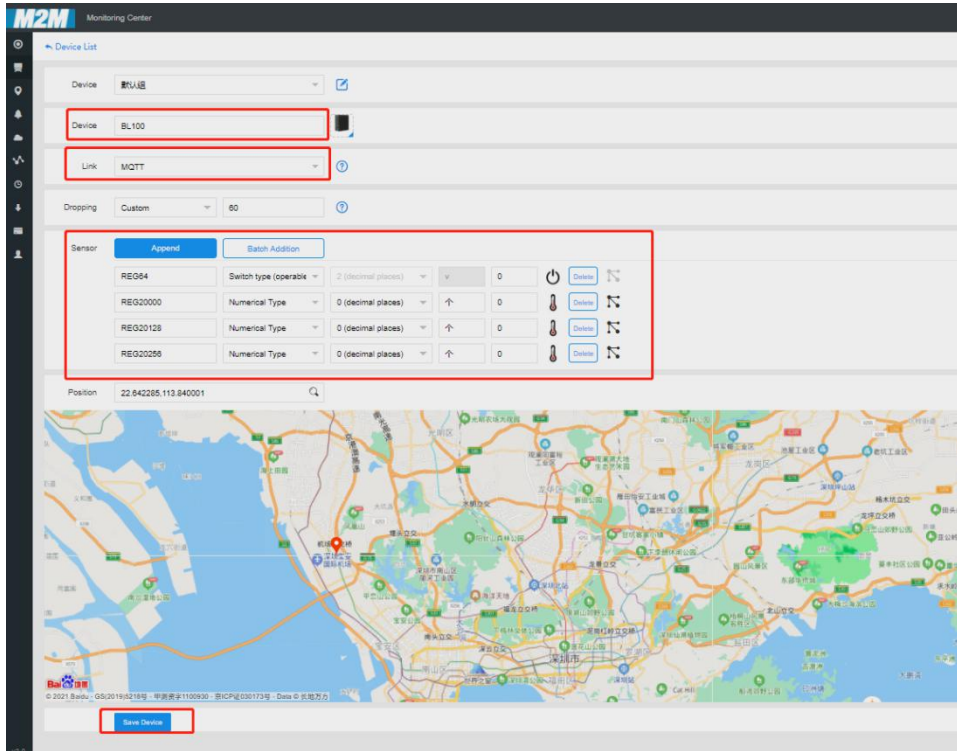

Set King Pigeon cloud modbus read & write command

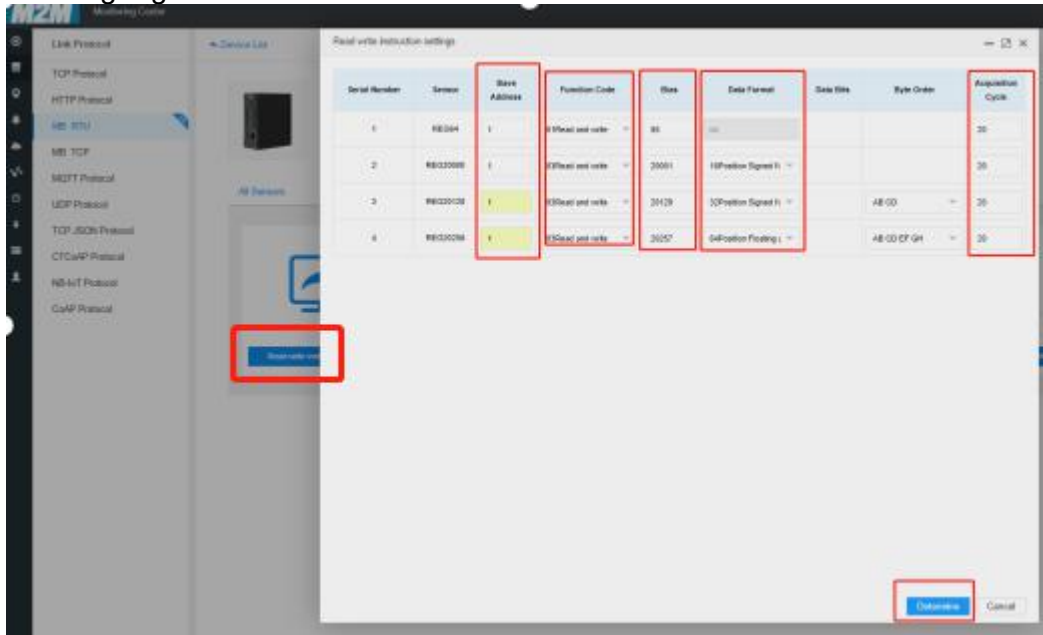

- Slave Address: Set BL100 device ID
- Function Code: select it according to slave type (refer to Appendix 6 Mapping Register Address for details)
- Bias: Add 1 to the address mapped to BL100 register. For example, if BL100 mapping register address is 64, then put 65 in cloud Bias
- Data Format: not necessary to set for boolean data. Select 16-bit, 32-bit, 64-bit data type according to actual status
- Byte Order: numeric row datapoint sequence (For details, refer to Appendix 6.4 Read Mapping Register Address)

- Acquisition Cycle: Interval of acquiring slave data

Once above setting is completed, device will be online after a while. Device datapoint status can be viewed from cloud.

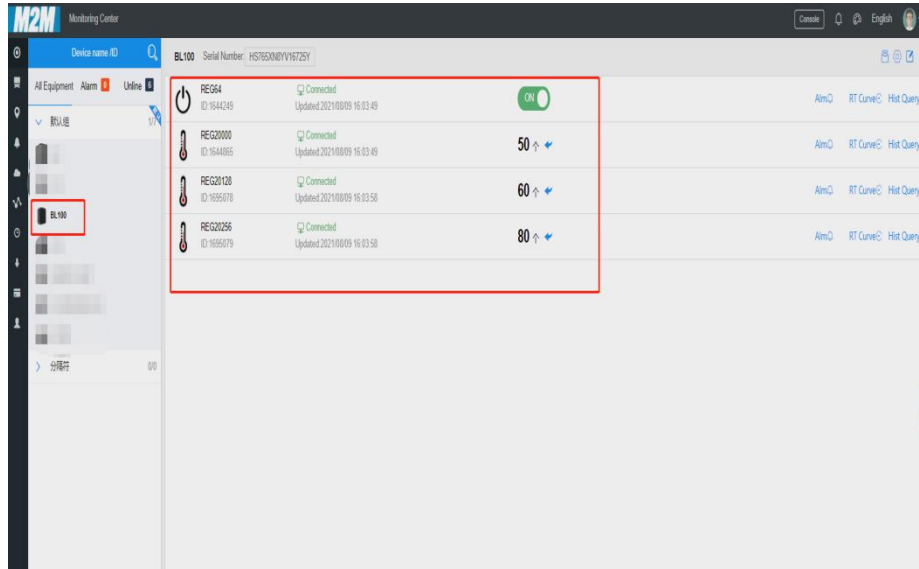

5.2.3 HUAWEI Cloud Application

In above part, serial port and slave datapoint have been set. To configure HUAWEI Cloud parameters, it's necessary to create device in HUAWEI Cloud first and get device ID, secret key and service ID. Below is the procedure:

- (1) Create product
- (2) Register device
- (3) Get service ID, device ID and secret key
- (4) Copy service ID, device ID and secret key to configuration software and save it
- (5) Device is online in HUAWEI Cloud

- ◆ Create Product

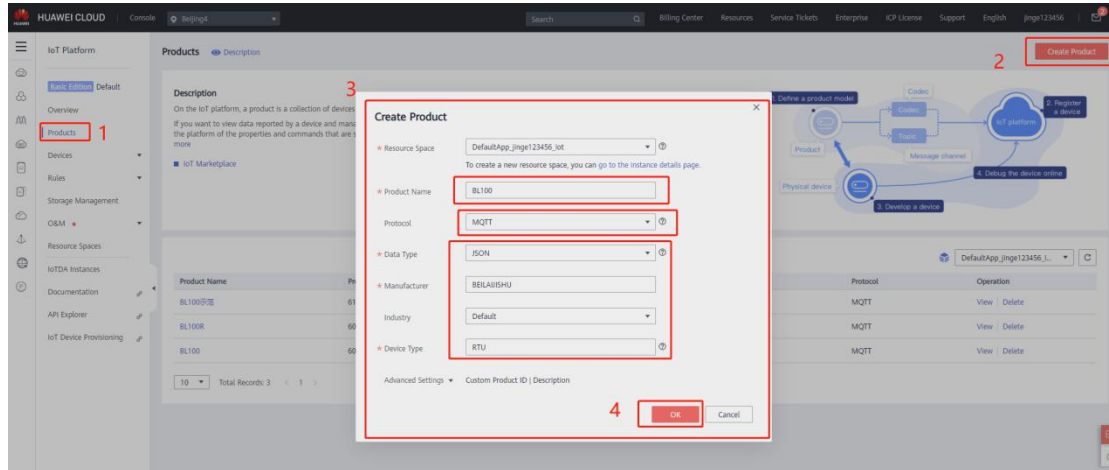

✓

Create product success

Product ID is: 610 bc56c0ad1ed02863b648

When this configuration huawei cloud is 1 d equipment

Then you can:

1. Define the product model
By defining the model, the platform to build an abstract model of the equipment, make the platform to understand the function of the
2. Add and debug the equipment
You can register the device under test, or use the platform provided by the simulator, online debugging

Check the
determine

◆ Add Service

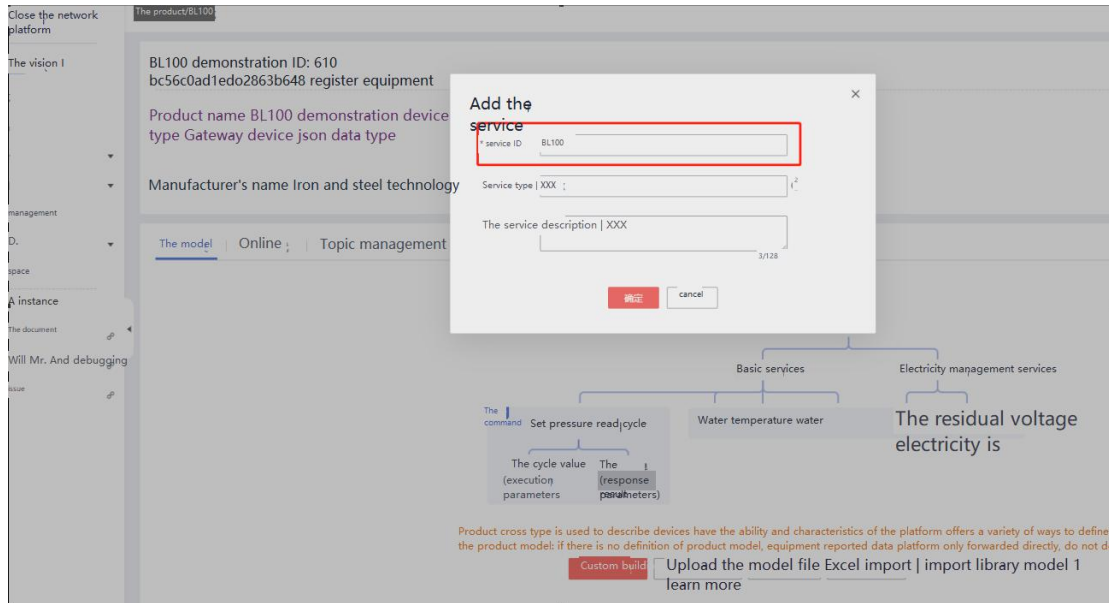

- ◆ Add Property: set data. Property name starts with REG. Select data type from boolean and numeric data. Property name is datapoint read-write mark. Refer to [6.2 Mapping Register Address](#) for details. For example, boolean slave mapping register address is 64, then property name is REG64

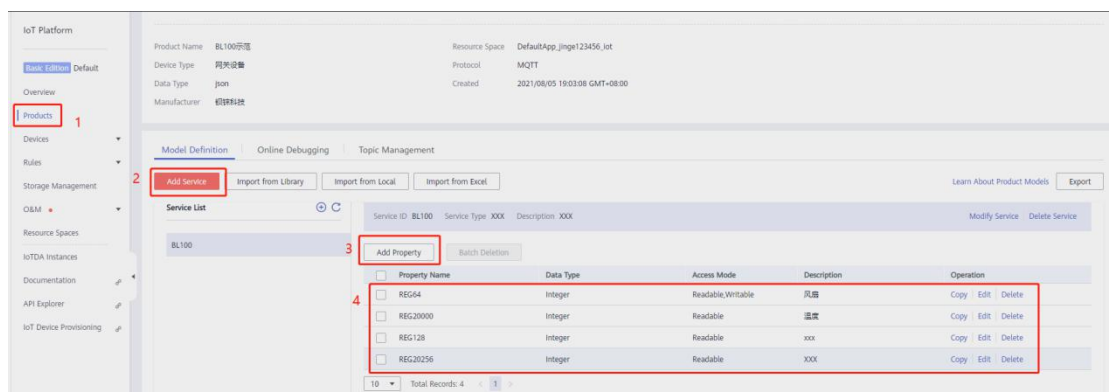
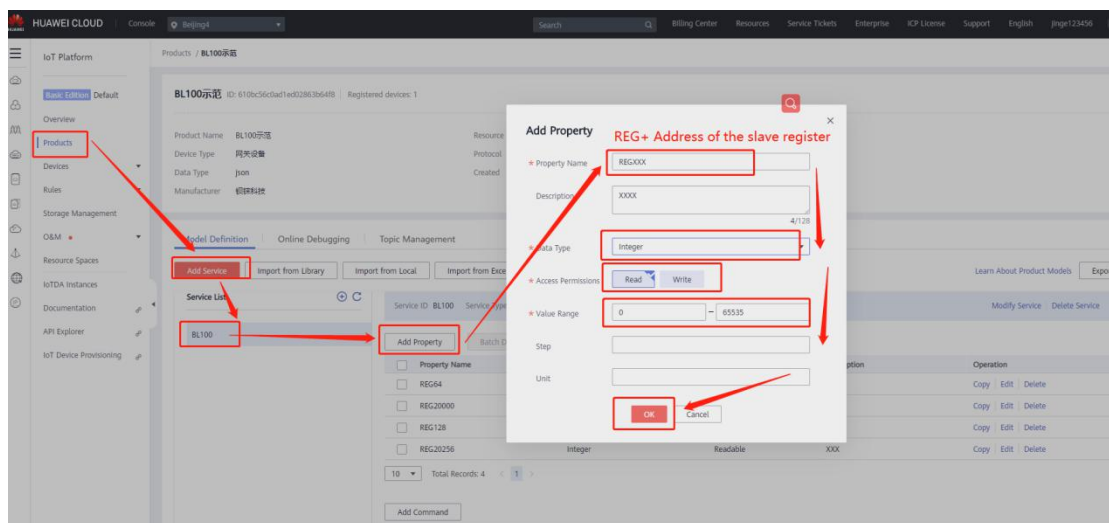

- ◆ Click Device to Register it

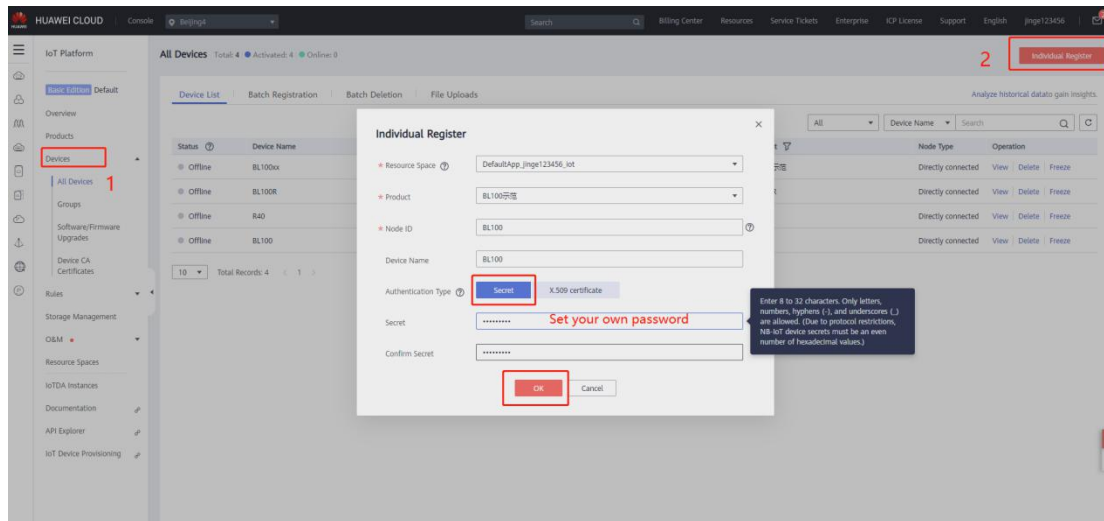

- ◆ Click OK to confirm it. Device Register Success notice box will pop out. Save below password and product ID

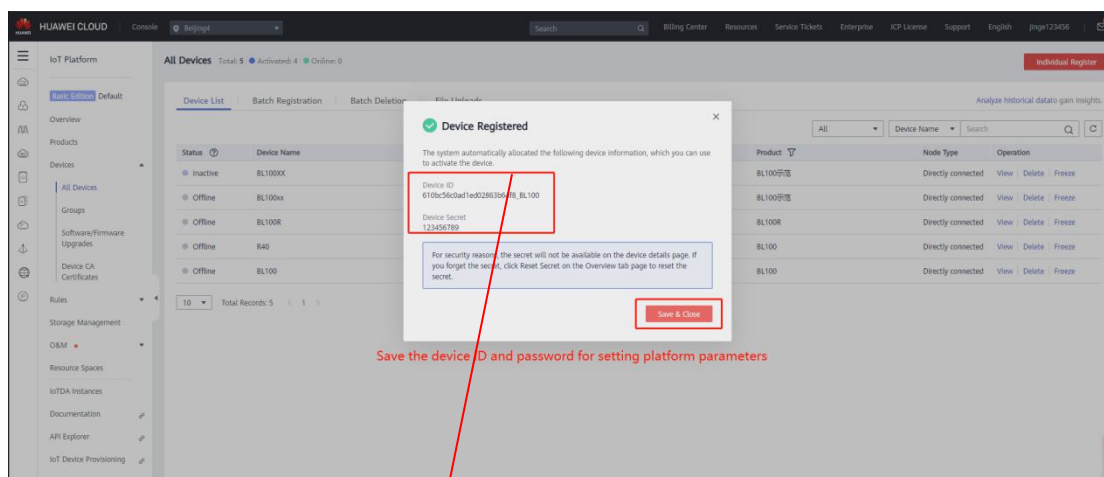

- ◆ Copy above device ID and secret and copy it to configuration software as below picture. Service ID is the same one that created in HUAWAI Cloud.

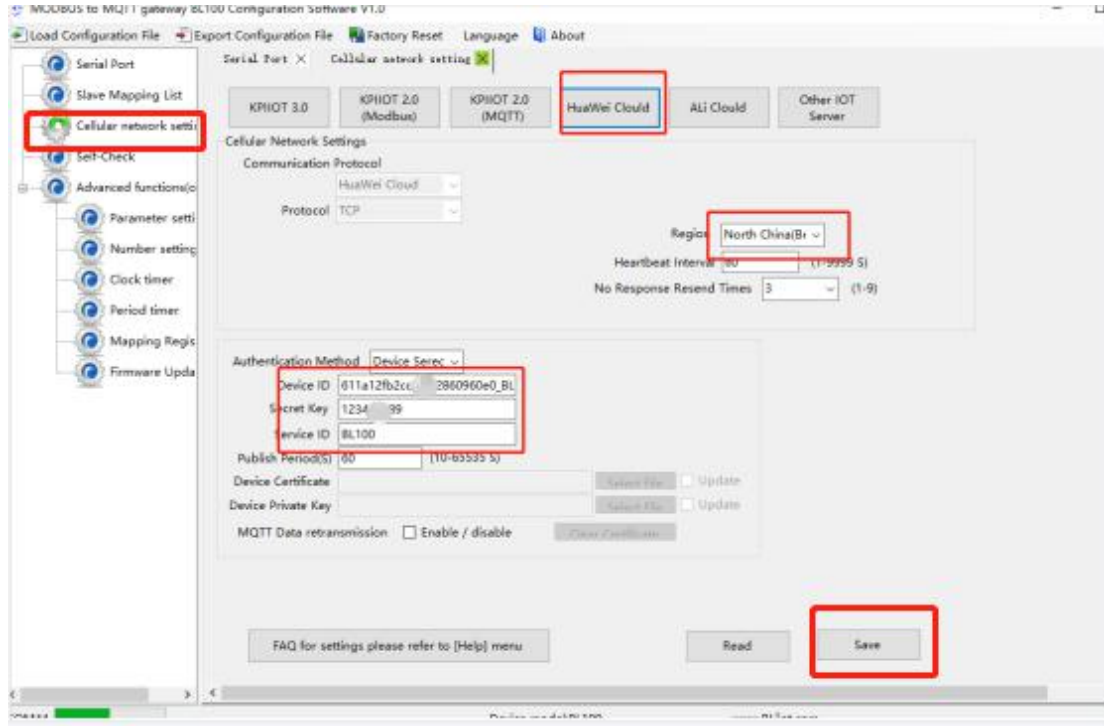

- ◆ Once configuration is done, wait for device to be online. Once it's activated, data can be viewed by clicking property

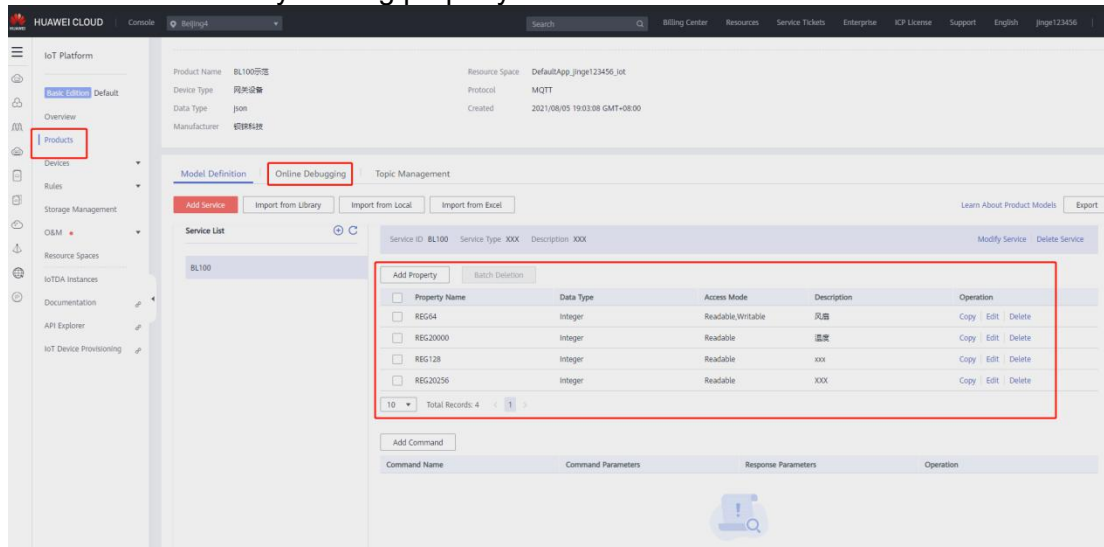

- ◆ Click Device-Device Debugging to view detailed device data sending and receiving.

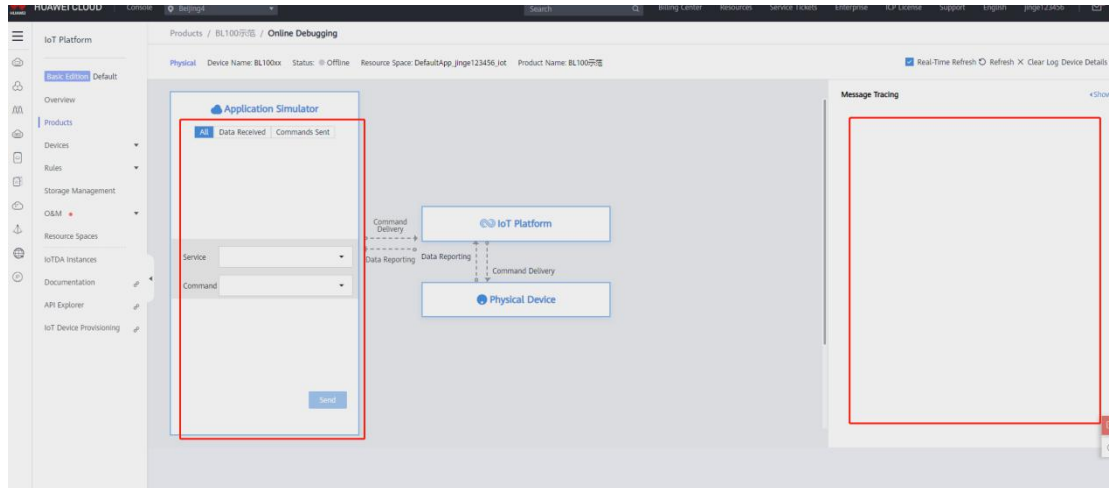

5.2.4 Alibaba Cloud Application

As stated above, serial port mode and slave device datapoint are set. It will not be repeated here. Before configuring Alibaba Cloud, it's necessary to create product in Alibaba cloud, add device and get device certificate, which is similar to configuring HUAWEI Cloud.

Step: Create product-Add Device-Get Certificate-Create Alibaba Cloud Data Point-Publish Device-Set Cloud Connection in Configuration Software-View Device in Cloud

◆ Create Product (Login to Alibaba Cloud Console)

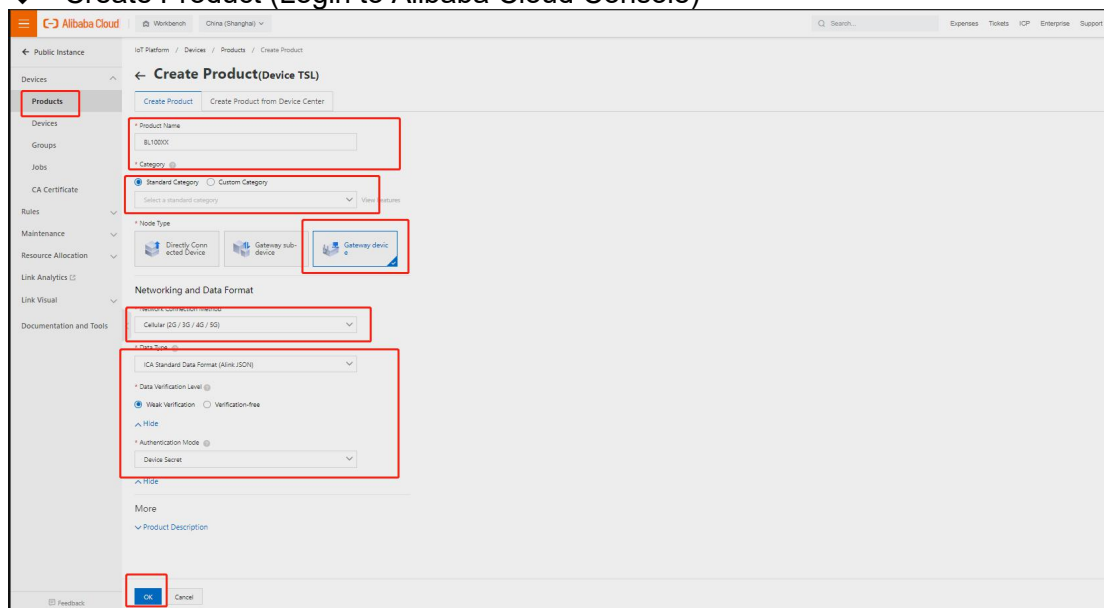

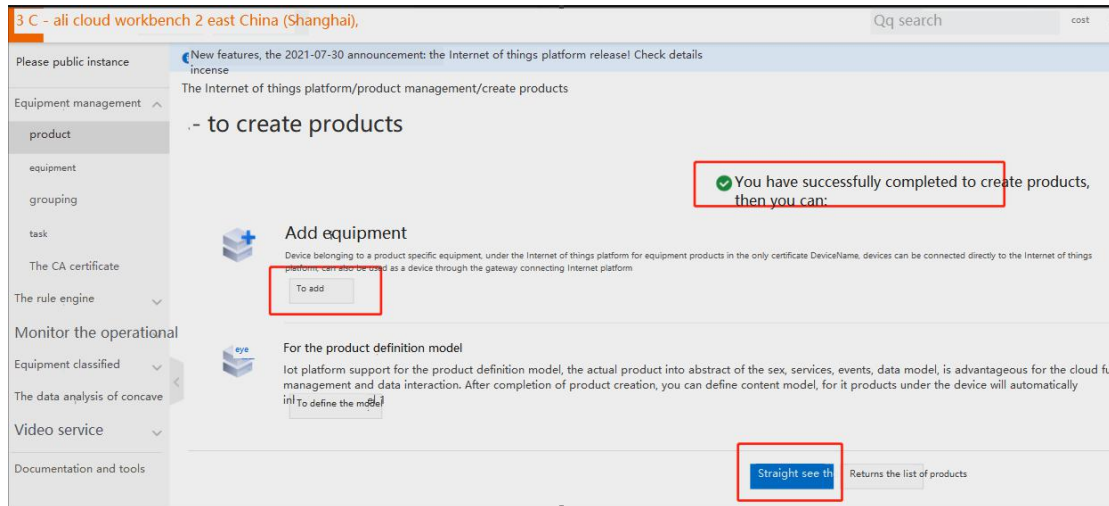

◆ Add Device

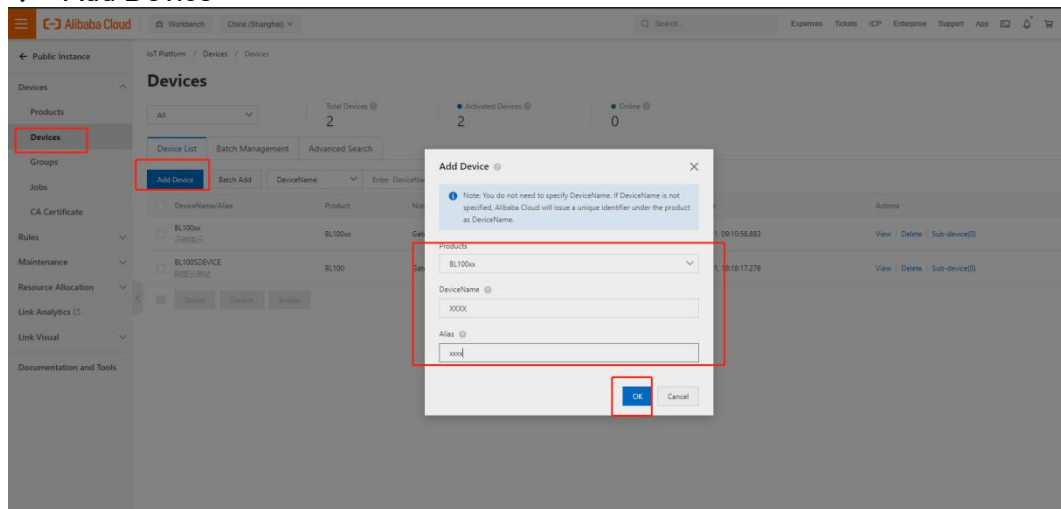

◆ Once device is added successfully, it can be viewed in console by clicking view. Click Copy to save it on desktop for following configuration

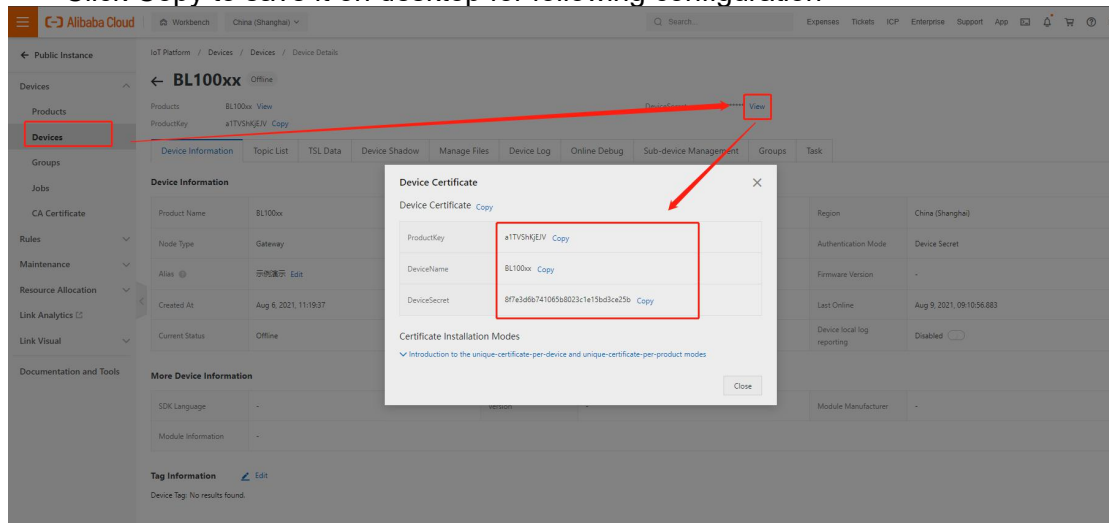

◆ Create Data Point

- Product--Device--Add Self-defined Features
 - Feature Name: Custom set it, like fan, light, temperature, light intensity, etc
 - Identifier: REG (XXX), put the corresponding mapping register according to datapoint to be added. Refer to [6.2 Mapping Register Address](#) for more details. For example, boolean slave mapping register address is 64, then identifier is "REG64"
 - Data Type: Boolean, Numeric, select it from drop-down menu.
 - Read/Write Type: Tick Read/Write or Read-only according to actual status
 - Description: provide any necessary description, can be blank

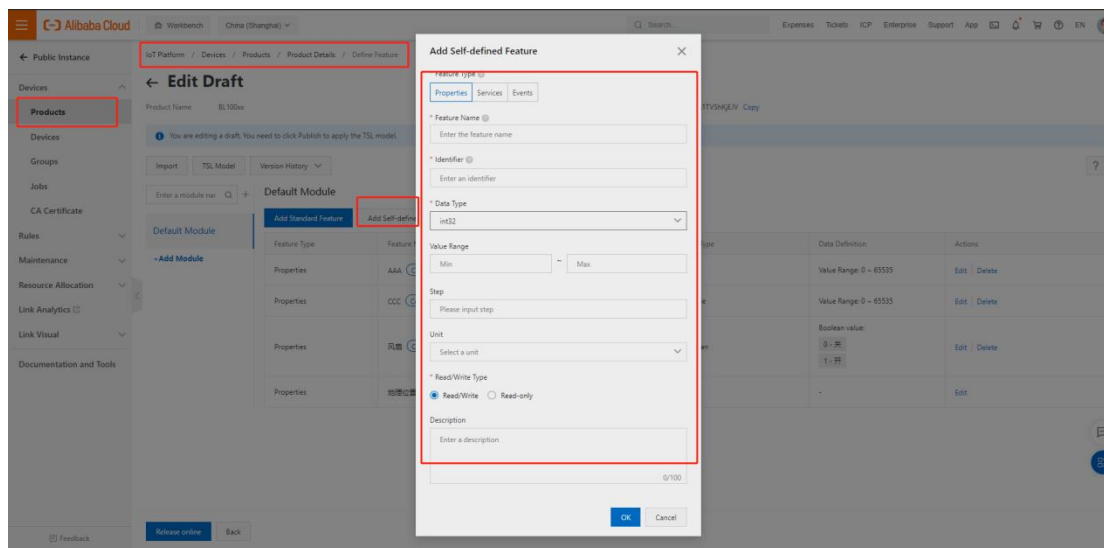
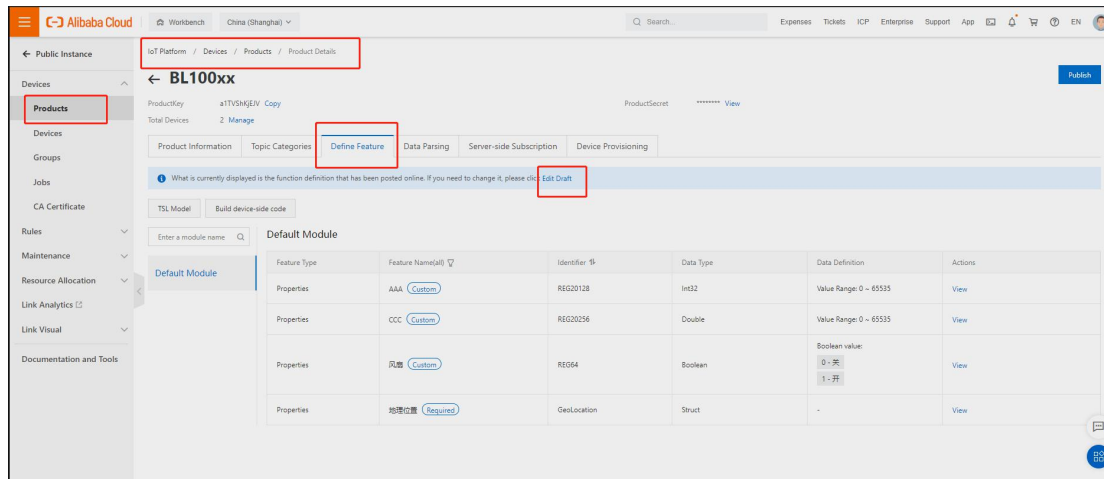

- ◆ Publish Device Data
Once data point is created, click Release Online

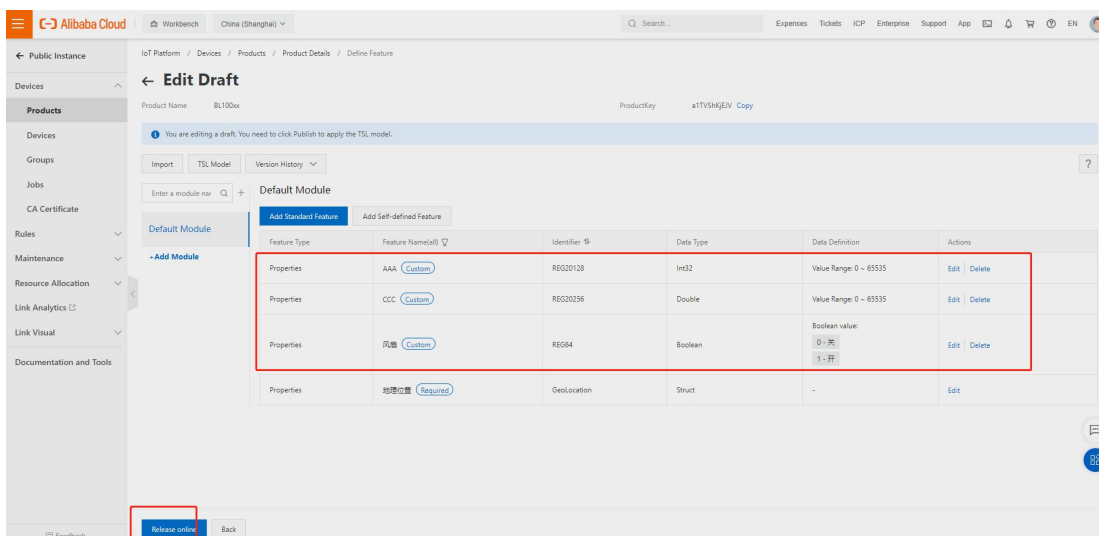

◆ Click Publish to enter below dialogue. Tick it and confirm it by clicking Accept

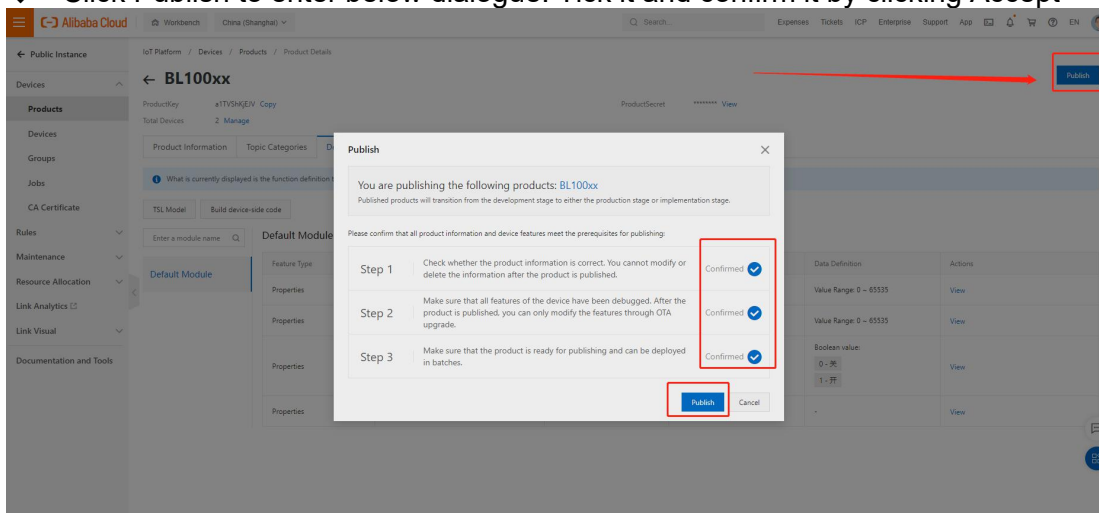

◆ Set Cloud Connection in Configuration Software: Copy the data saved on desktop and paste it in configuration software. It can be viewed from Alibaba cloud device view page as well.

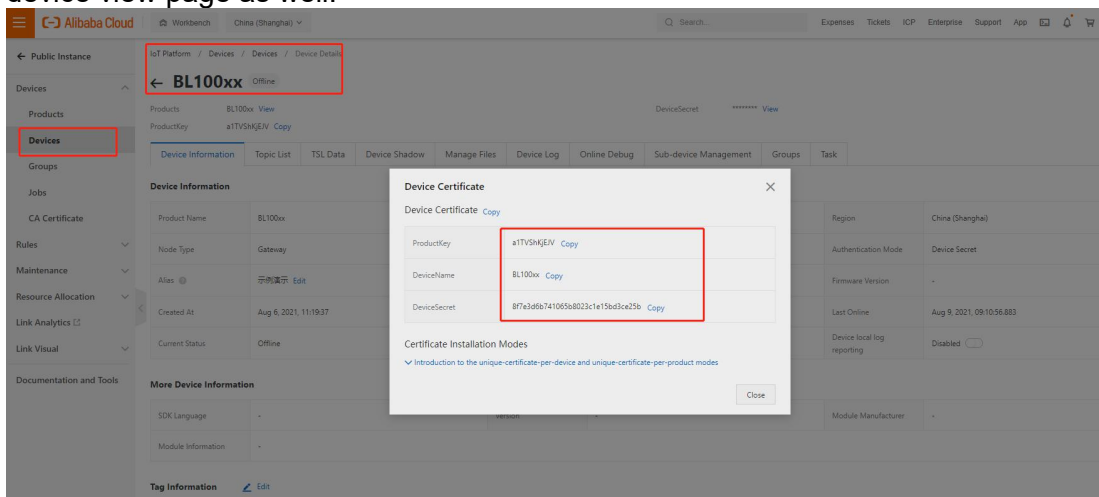

- ◆ Enter above parameter in configuration software and click save to complete it. Return to Alibaba cloud and wait for device to be online

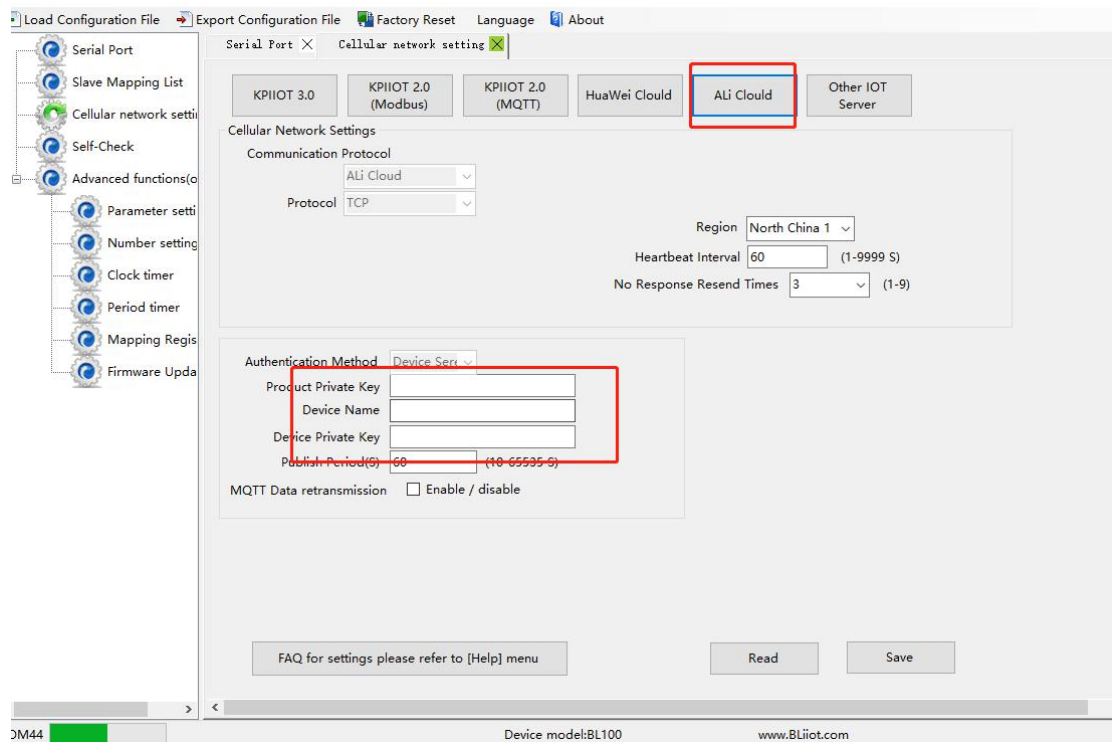

- ◆ Before device is online, it's inactivated. Once it's connected successfully, the status will be online like below picture.

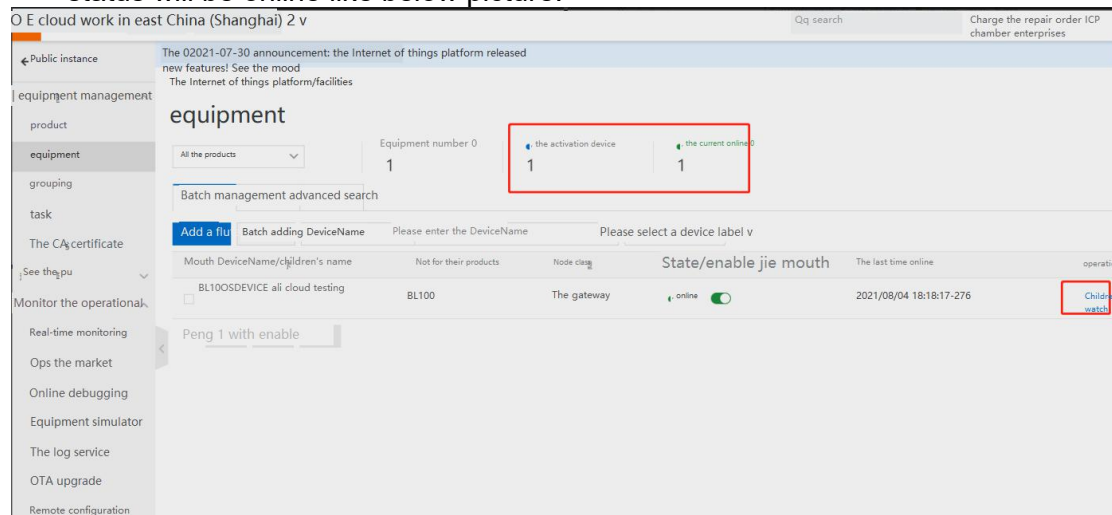

- ◆ Data point read-and-write can be performed in device online debug page.

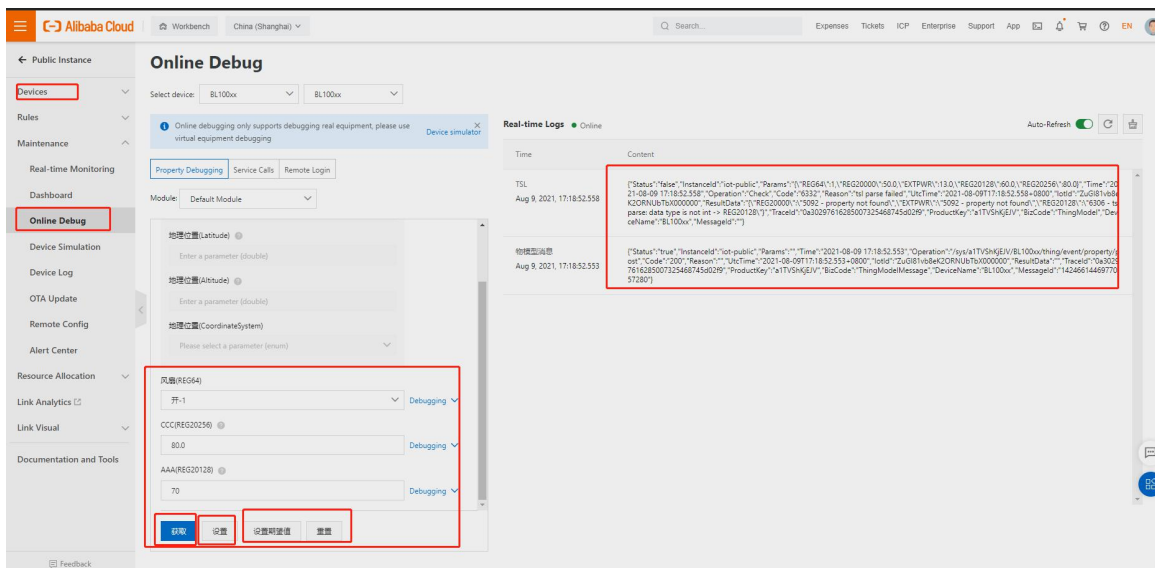

5.2.5 MQTT Application

MQTT Principle

There're 3 roles in MQTT protocols: Publisher, Broker(Server) and Subscriber. Message publisher and subscriber are client. Message broker is server. Publisher can be subscriber at the same time. Below is the example of connecting BL100 to King Pigeon Cloud 2.0:

When Device Publishes I/O Data:



When User Controls Devices:



- Client Configuration
- ◆ Enter device serial number only

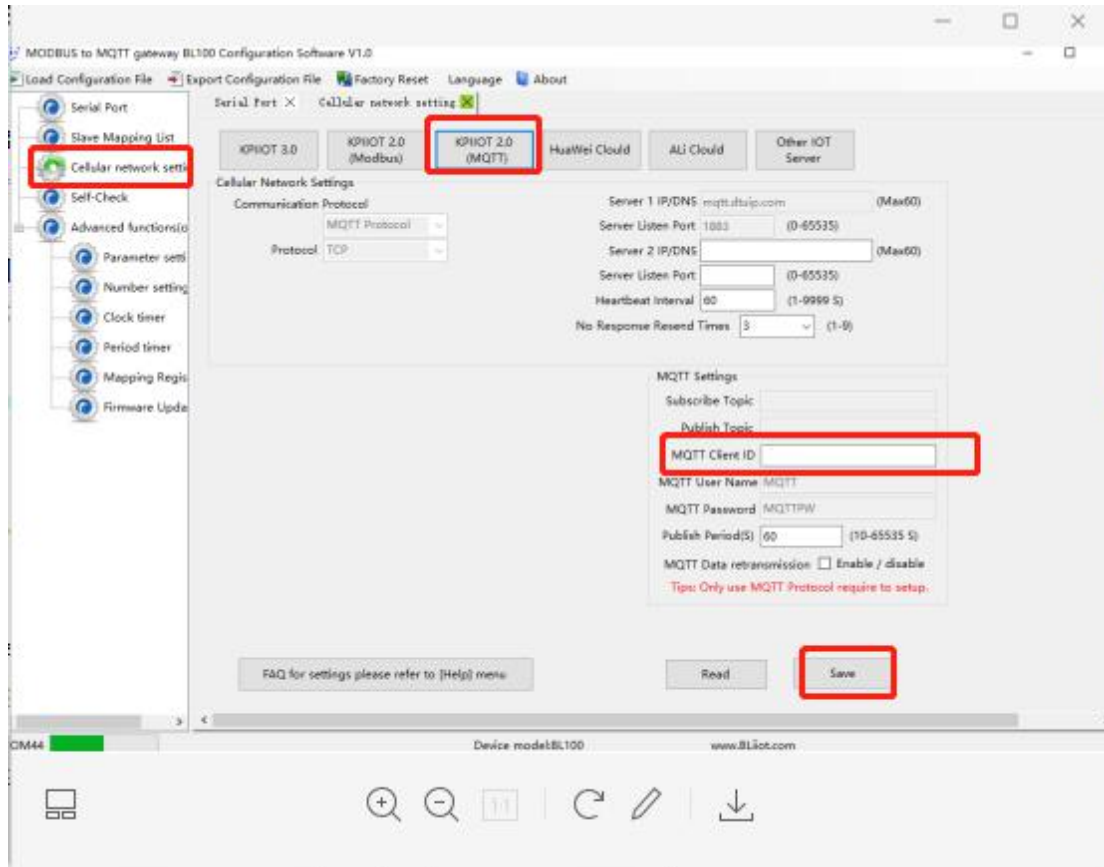

- ◆ Create device and data point in King Pigeon Cloud

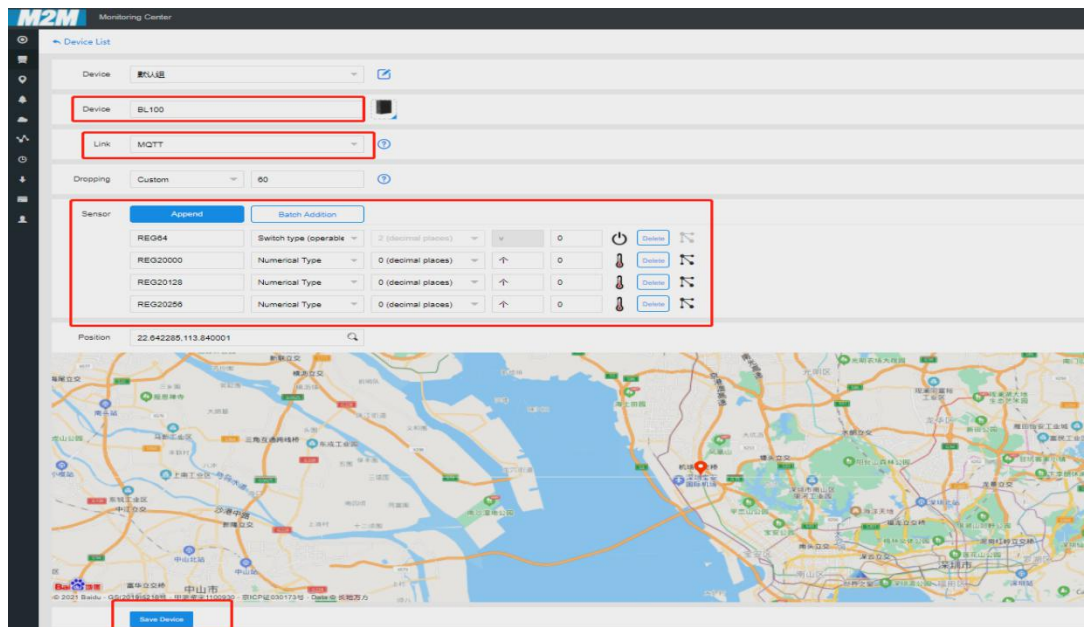

- ◆ Read-Write identifier setting. Slave identifier starts with REG plus mapping register. Refer to [6.2 Mapping Register Address](#) for details

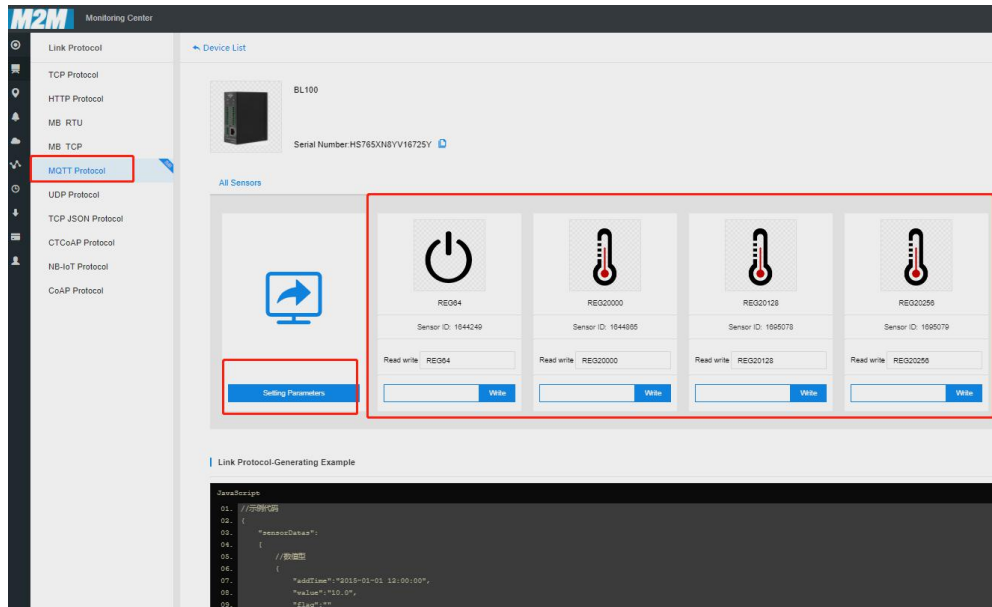

◆ Data View and Dissemination

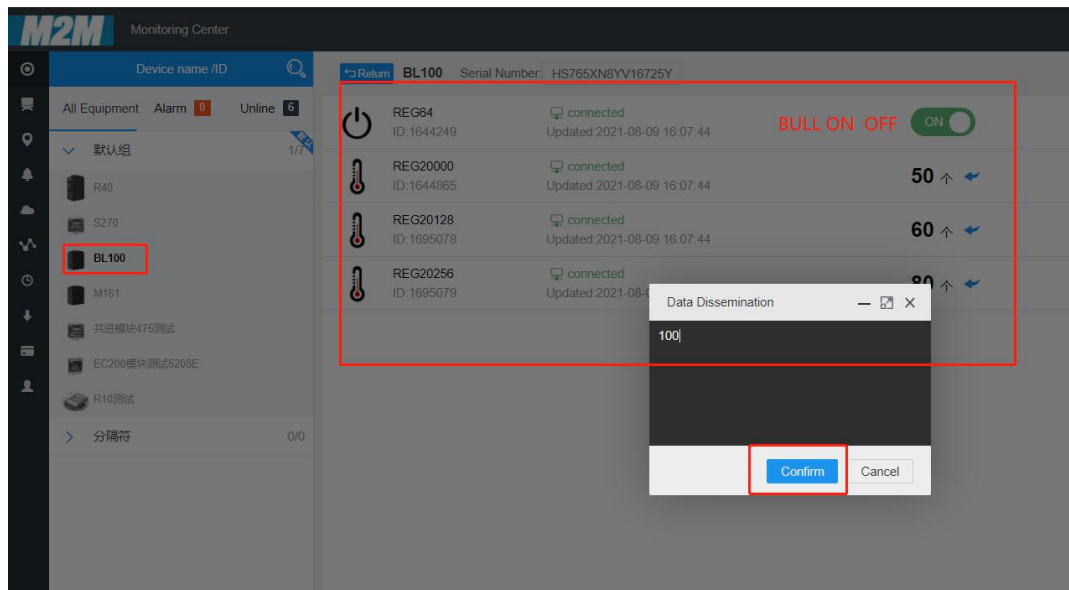

◆ Valid Payload Data Format in Device Publishing Message

Publishing Topic: Serial Number(same as the configured publishing topic)

```

{
  "sensorDatas": [
    {
      //Boolean value
      "flag": "REG64", //Read-Write Identifier
      "switcher": 1//Data Type and Value
    },
    {
      //Numeric Type
      "flag": "REG20000", //Read-Write Identifier
      "value": 30 //Data Type and Value
    }
  ]
}

```

```

    }
  ],
  "state": "alarm", //Alarm Identifier (Only exist when Alarm & Event is configured
    and alarm is triggered. It's not included in scheduled regular reporting)
  "state": "recovery", //Alarm Recover Identifier (Only exist when there's alarm
    recovery. It's not included in scheduled regular reporting)
  "time": "1622700769", //Time Identifier, timestamp of data publishing
  "retransmit": "enable" //Re-transmission Identifier (only exist when there's
    historical data re-transmission. It's not included in scheduled regular reporting)
}

```

Note:

//Read-Write Identifier: character is "flag", followed by datapoint MQTT identifier,
(The same MQTT identifier set in adding datapoint, can be customized)

//Data Type and Value: can be categorized as below:

1. Boolean data: character is "switcher", followed by "0" or "1" (0 is open, 1 is closed)
2. Numeric Data: Character is "value", followed by actual value

//Alarm, Recovery Identifier: character is "state", followed by "alarm" or "recovery"
(alarm is alarm data, recovery is alarm recovery data)

//Time identifier: character is "time", followed by actual timestamp of data
reporting

//Re-transmission Identifier: character is "retransmit", followed by "enable"

Device offline data will be saved temporarily. Once network resumes, it will be
re-transmitted. Identifier "retransmit" refers to historical data (need to be enabled in
configuration software)

◆ Valid Payload Data Format in Device Subscribing Message

Subscribe Topic: Device Serial Number/+ (same as the subscribe topic in
configuration software)
(King Pigeon Cloud 2.0 use "device serial number/sensor ID" as publishing topic.
Thus Subscribe Topic must add wildcard character /+ to realize device control from
cloud

```

{
  "sensorDatas":
  [
    {
      "sensorId": 211267, //Cloud Sensor ID
      "switcher": 1, //Data Type and Value
      "flag": "REG65" //Read-Write Identifier
    }
  ],
  "down": "down" //Cloud Downlink Message Identifier
}

```

Note:

//Cloud Sensor ID: character is "sensorID", followed by ID number (ID is generated
by cloud automatically. Ignore this part for self-built cloud platform)

//Data Type and Value. Can be categorized as below:

1. Digital Data: character is "switcher", followed by "0" or "1" (0 is open, 1 is closed)
2. Numeric Data: character is "value", followed by actual value

//Read-Write Identifier: character is "flag", followed by datapoint MQTT identifier

//Cloud Downlink Message Identifier: character is "down", followed by "down", it's
cloud mapping register slave mapping address identifier

Item Name	MQTT Read-Write Identifier	Data Type
Boolean Data Type	REG64~127	Switcher
16-bit Data Type	REG20000~20127	Value
32-bit Data Type	REG20128~20254	Value
64-bit Data Type	REG20256~20508	Value

5.2.6 Self-Defined Cloud Platform

BL100 supports customer self-defined cloud platform with Modbus RTU, Modbus TCP and MQTT protocol.

Custom MQTT protocol data format is the same as King Pigeon Cloud 2.0 MQTT data format. Refer to [5.2.5 MQTT Application](#) for more details. Modbus RTU and Modbus TCP are standard Modbus protocols. Refer to Appendix 6.3, 6.4 and 6.5 for message data details.

Operation Procedure is the same as above:

- (1) configure serial port mode
 - (2) Create slave device datapoint
 - (3) Configure self-defined cloud platform parameters
- Refer to below picture

- ◆ Cellular Network Setting- Select Other IOT Server-Select Communication Protocol-Enter Server IP/Domain Name and port number. Click Save.

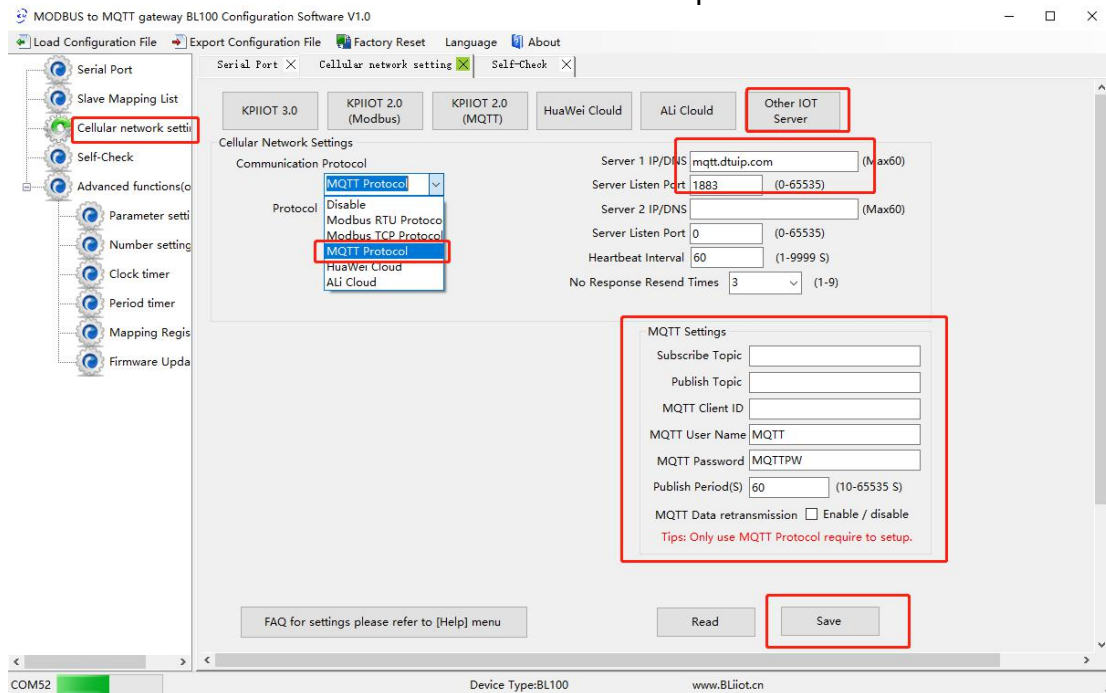

6 Appendix Register Address

6.1 BL100 Device Register Address

- ◆ Hold Register Type, Read-Write, support function code 03

Register Address		Data Name	Data Type	Description ^①
Hexadecimal	Decimal			
22A	554	Signal Value	16bit int	Y=X

- ◆ Input Register Type, Read-Only, support function code 04

Register Address		Data Name	Data Type	Description ^①
Hexadecimal	Decimal			
0	0	Power Supply Voltage	16bit int	Y=X/100

6.2 Mapping Register Address

Note: expanded I/O identifier is: "REGx"(x is Modbus register address)

- ◆ Boolean slave mapping register address: hold coil, function code 01/05/15

Mapping Register Address		Data Name	Read-Write Identifier	Data Type	Description ^①
Hexadecimal	Decimal				
40	64	Bool 64	REG64	Bool	Boolean bit type, can map slave input coil and hold coil status. Total 64 addresses
41	65	Bool 65	REG65	Bool	
42	66	Bool 66	REG66	Bool	
...	Bool	
...	Bool	
7F	127	Bool 127	REG127	Bool	

- ◆ 16-bit data type slave mapping register address: hold register, Read-Write, support function code 03/06/16

Mapping Register Address		Data Name	Read-Write Identifier	Data Type	Description
Hexadecimal	Decimal				
4E 20	20000	16-bit data 20000	REG20000	Order AB, actual data type is decided by slave mapped data	Set mapping rule according to configuration software. Data order is AB and saved in the address for Read-Write in cloud. Can map slave input register and hold register. Total 128 addresses
4E 21	20001	16-bit data 20001	REG20001		
4E 22	20002	16-bit data 20002	REG20002		
...		
...		
4E 9F	20127	16-bit data 20127	REG20127		

- ◆ 32-bit data type slave mapping register address: hold register, Read-Write, support function code 03/06/16

Mapping Register Address		Data Name	Read-Write Identifier	Data Type	Description
Hexadecimal	Decimal				
4E A0	20128	32-bit data 20128	REG20128	Order ABCD, actual data type is decided by slave mapped data	Set mapping rule according to configuration software. Data order is ABCD and saved in the address for Read-Write in cloud. Total 64 addresses.
4E A2	20130	32-bit data 20130	REG20130		
4E A4	20132	32-bit data 20132	REG20132		
...		
...		
4F 1E	20254	32-bit data 20254	REG20254		

- ◆ 64-bit data type slave mapping register address: hold register, Read-Write, support function code 03/06/16

Mapping Register Address		Data Name	Read-Write Identifier	Data Type	Description
Hexadecimal	Decimal				
4F 20	20256	64-bit data 20256	REG20256	Order ABCDEFGH, actual data type is decided by slave mapped data	Set mapping rule according to configuration software. Data order is ABCDEFGH and saved in the address for Read-Write in cloud. Can map slave input and hold register. Total 64 addresses
4F 24	20260	64-bit data 20260	REG20260		
4F 28	20264	64-bit data 20264	REG20264		
...		
...		
50 1C	20508	64-bit data 20508	REG20508		

6.3 Edit Boolean Mapping Address Data

If it's necessary to control relay connected to RS485 slave, function code 15 for slave writing must be added in slave list of configuration software. Once mapping address is changed, RS485 slave address data will be written accordingly.

- ◆ Message Format from Master Station

Message Content	Byte Qty	Data Example	Description
Device Address	1	01H	Device 01H , range: 1-247, follow the set address
Function	1	05H	Write single hold coil, use function code 05H
Boolean Mapping	2	00 40H	Range 00 40H-00 7FH, refer to

Register Address			Appendix B Mapping Register Address for details.
Written Value	2	FF 00H	Value is FF 00H or 00 00H. FF 00H is writing 1, 00 00H is writing 0
16 CRC Check	2	8D EEH	CRC0 CRC1 low byte is in front of high byte

◆ Returned Message Format from device:

Content	Byte	Data Example	Description
Device Address	1	01H	Device 01H, same address as received
Function	1	05H	Write single hold coil
Boolean Mapping Register Address	2	00 40H	Range: 0040H-007FH
Written Value	2	FF 00H	Value is FF 00H or 00 00H. FF 00H is writing 1, 00 00H is writing 0
16 CRC Check	2	8D EEH	CRC0 CRC1 low byte is in front of high byte

◆ Example: change value of Boolean mapping address 64, change it to 1:

Server sends: 01 05 00 40 FF 00 8D EE

Note:

01: Device Address
 05: Write Boolean value
 00 40: Mapping Address of value to be changed
 FF 00: Write 1
 8D EE : 16-bit CRC check

Device Returns: 01 05 00 40 FF 00 8D EE

Note:

01: Device Address
 05: Write Boolean Value
 00 40: Mapping Address to write value
 FF 00: Write 1
 8D EE : 16-bit CRC Check

If more values to be changed, please refer to details of function code 15 in Modbus protocol.

6.4 Read Numeric Mapping Address Data

◆ Message Format from Server Master:

Content	Byte	Data Example	Description
Device Address	1	01H	Device 01H, Range 1-247, same as the set address
Function Code	1	03H	Read hold register, use function code 03
Starting Address of Mapping Register	2	4E 20H	Numeric data mapping address range, refer to Appendix B Mapping Register Address for details
Qty of Mapping Registers to be Read	2	00 0AH	Qty of input registers to be read



16 CRC Check	2	3D 2FH	CRC0 CRC1 low byte is in front of high byte
--------------	---	--------	---

◆ Return Message Format from Device

Content	Byte	Data Example	Description
Device Address	1	01H	Device 01H, same device ID as that in received message
Function Code	1	03H	Read hold register
Return Data Byte	1	14H	
Return Data	20	00 14 00 1E 00 28 00 32 00 4B 00 41 00 0A 00 25 00 14 00 2AH	Return data
16 CRC Check	2	FB 34H	CRC0 CRC1 low byte is in front of high byte

◆ Example: mapping address starts with 20000 and read 10 addresses data:

Server sends: 01 03 4E 20 00 0A D3 2F

Note:

- 01: Device Address
- 03: Read hold register
- 4E 20: Starting address of mapping register, current data is decimal 20000
- 00 0A: Read 10 registers' value
- D3 2F: 16 -bit CRC check

Device returns: 01 03 14 00 14 00 1E 00 28 00 32 00 4B 00 41 00 0A 00 25 00 14 00 2A FB 34

Note:

- 01: Device Address
 - 03: Read hold register
 - 14: Return 20 bytes
- 00 14 00 1E 00 28 00 32 00 4B 00 41 00 0A 00 25 00 14 00 2A; Return data

Mapping Register Address	20009	20008	20007	20006	20005	20004	20003	20002	20001	20000
Value	00 2A	00 14	00 25	00 0A	00 41	00 4B	00 32	00 28	00 1E	00 14

FB 34 : 16 -bit CRC Check

6.5 Edit Numeric Mapping Address Data

To change data of slave device connected through RS485, it's necessary to add read-write function code 16 in slave list of configuration software. Once mapping address value is changed, the corresponding address data of slave connected through RS485 will be changed accordingly

For example, mapping address is 20000 and slave mapping data is signed integer type and order is AB

◆ Message Format from Sever Master Station:

Content	Byte	Data Example	Description
Device Address	1	01H	Device 01H, range: 1-247, same as the set address
Function Code	1	06H	Write single hold register, use function code 06
Mapping Register Address	2	4E 20H	Address range: 4E 20H-50 1CH, refer to Appendix 6.2 Mapping Register Address for details of mapped data address range
Written Data	2	00 64H	Data example, write decimal data value 100
16 CRC Check	2	9E C3H	CRC0 CRC1 low byte is in front of high byte

◆ Return Message Format from Device:

Content	Byte	Data Example	Description
Device Address	1	01H	Device 01H, same as the address in received message
Function Code	1	06H	Write single hold register
Mapping Register Address	2	4E 20H	Address range: 4E20H-501CH
Written Data	2	00 64H	Write 100 successfully
16 CRC Check	2	9E C3H	CRC0 CRC1 low byte is in front of high byte

◆ Example: if mapping address is 20000 and slave mapping data is signed integer type with AB order, change mapping address 20000 value to 100:

Server sends: 01 06 4E 20 00 64 9E C3

Note:

01: Device Address
 06: Change single hold register value
 4E 20: Change value of register address 20000 register
 00 64: Write decimal value 100
 9E C3: 16-bit CRC check

Device returns: 01 06 4E 20 00 64 9E C3

Note:

01: Device Address
 06: Change single hold register value
 4E 20: Change value of register address 20000
 00 64: Change to decimal value 100
 9E C3 : 16 -bit CRC check

To change more numeric data type mapping address, please refer to details of function code 16 in Modbus protocol

6.6 SMS Function

BL100 support remote configuration, inquiry and control with SMS. Below are the notice points:

1. Default device password is 1234. It can be changed with SMS for safety
2. Password in SMS commands refers to device password, for example if device password is 1234, directly enter 1234
3. "+" in SMS commands means plus without any content, please don't add any space or character
4. Capital and lower case letters must be clarified. For example, PWD should be not be entered as pwd
5. If password is correct but command is wrong, device will return message: Wrong command format, please confirm! Thus please check inputting method, capital and lower case letters
6. If device password is wrong, there will be no message returned.
7. Device will return message once it receives SMS commands. If no return message, please check whether password is wrong or network signal is not good.

6.6.1 SMS Commands

Change Password

Action	Command	Return Message
Change Password	Old password+P+new password	This is new password, please remember!

Arm/Disarm

Action	Command	Return Message
Arm	password+AA	Armed
Disarm	password+BB	Disarmed

Inquire Device Status

Action	Command	Return Message
Inquire Device Status	password+EE	Arm/Disarm: xxx Model: xxx Version: xxx IMEI: xxx GSM signal value: xxx

Set User Number

Action	Command	Return Message
Set User Number	password+A+number+T+user number Number: 0~9	Telx: ---
Inquire	password+A	Return all user numbers
Delete	password+A+number	Return number 0~4 and 5~9

Set Server (Cellular Network)

Action	Command	Return Message
Set Server	password+IP+IP address+P+port number	Server: Port:
Inquire	password+IP	
Delete	password+IPDEL	

Set Cellular Network Parameters

Action	Command	Return Message
Set	password+AP+APN#+#user name#+#user password	APN: User Name: Password:
Inquire	password+AP	
Delete	password+APDEL	

Reboot Device

Action	Command	Return Message
Reboot Device	password+Reboot	No return message

Note: There will be no return message for rebooting device with SMS. Tick Alarm automatically when power on in configuration software. Once device is rebooted successfully, SMS will be sent to user

7 After-Sale Service

7.1 Firmware Upgrading

This device has modular design. If telecommunication operators upgrade network, it's not necessary to change the whole hardware but only communication modules.

It supports firmware upgrading through USB interface. If any new requirement for firmware upgrading, please contact us directly.



7.2 Warranty Term

This device has one-year warranty from the day of purchase for any quality problems. Any faulty caused by human damage or wrong operations is beyond warranty

7.3 Technical Support

King Pigeon Communication Co., Ltd.

Tel: +86 755-29451836

Website: www.iot-solution.com