

LoRa Gateway Wireless Data Acquisition



S281 User Manual

Ver 1.0

Date Issued: Aug 21st, 2019
King Pigeon Hi-Tech. Co., Ltd.

www.iot-solution.com



【Foreword】

Thank you for using the S281 LoRa wireless data acquisition module of Shenzhen King Pigeon Hi-Tech Co., Ltd. Read this product user manual to help you to know the function and usage of this product quickly.

【Copyright Notice】

All rights reserved belongs to Shenzhen King Pigeon Hi-Tech Co., Ltd, No company or individual has the right to copy, duplicate or transmit any parts of this manual in any forms. Otherwise Shenzhen king Pigeon Hi-tech.,Ltd will reserve the right of legal responsibility.

【Disclaimer】

This product is mainly used for wireless data transmission application based on LoRa technology. Please follow the parameters and technical specifications provided in the manual, and pay attention to the precautions when using the product. The Company shall not bear any property or personal injury caused by the improper use or improper use of this product.

【Document Revision Record】

Update date	Version	Description
2019.06.29	V1.00	1st Version



Table of Contents

1. Brief Introduction.....	4
1.1 Overview.....	4
1.2 Typical Application.....	5
1.3 Packing List	6
1.4 Features.....	8
1.5 Gateway Technical Parameter.....	9
2. Hardware illustration.....	10
2.1 ID.....	11
2.2 LED Indicator.....	12
2.3 Interface Definition.....	12
2.4 Installation.....	13
3. Configuration.....	14
3.1 Before Configuration.....	14
3.2 Basic Setting.....	16
3.3 Alarm Numbers Setting.....	18
3.4 Timer Setting.....	18
3.5 Cellular Network Setting.....	19
3.6 Ethernet Setting.....	20
3.7 Add slave device.....	23
3.7.1 Slave device spec.....	23
3.8 Manage slave device.....	29
3.9 History Record.....	29
3.10 Alarm Record.....	30
4. Upgrade Firmware.....	31
5. Warranty Terms.....	31
6. Technical Support.....	31
Appendix A SMS Command.....	31
Appendix B Modbus Register Address.....	36
Appendix C Communication Protocol.....	36
1. Modbus RTU Protocol.....	37
2. Modbus TCP Protocol.....	37

1. Brief Introduction

1.1 Overview

S281 is wireless data ,wireless temperature and humidity acquisition & alarm system. It is based on LoRa radio, mainly used for multi-point and long-distance distributed temperature and humidity acquisition and transparent transmission from equipment to cloud platform. LoRa modulation technology is adopted to realize on-site distributed multi-point IO equipment monitoring and temperature & humidity collection. Communication distance can be up to 1km. Built-in LoRa SX1278 chip, GSM/GPRS/3G/4G/RJ45 module, S281 can transfer sensor, PLC, smart meter and other data via wireless RF, and then through SMS/2G/3G/4G/Ethernet Send it to the cloud platform or mobile phone to realize remote monitoring and control, and solve the problem of on-site wiring.

This system includes LoRa gateway and LoRa slave device. LoRa slave devices connect sensors, PLC and other devices, and transfer data to cloud, phone App via RF. It realizes the dual communication between cloud and PLC or other devices. When slave device acquires temperature & humidity data, alarm values can be set by gateway to realize SMS alarm.

S281 System Topology

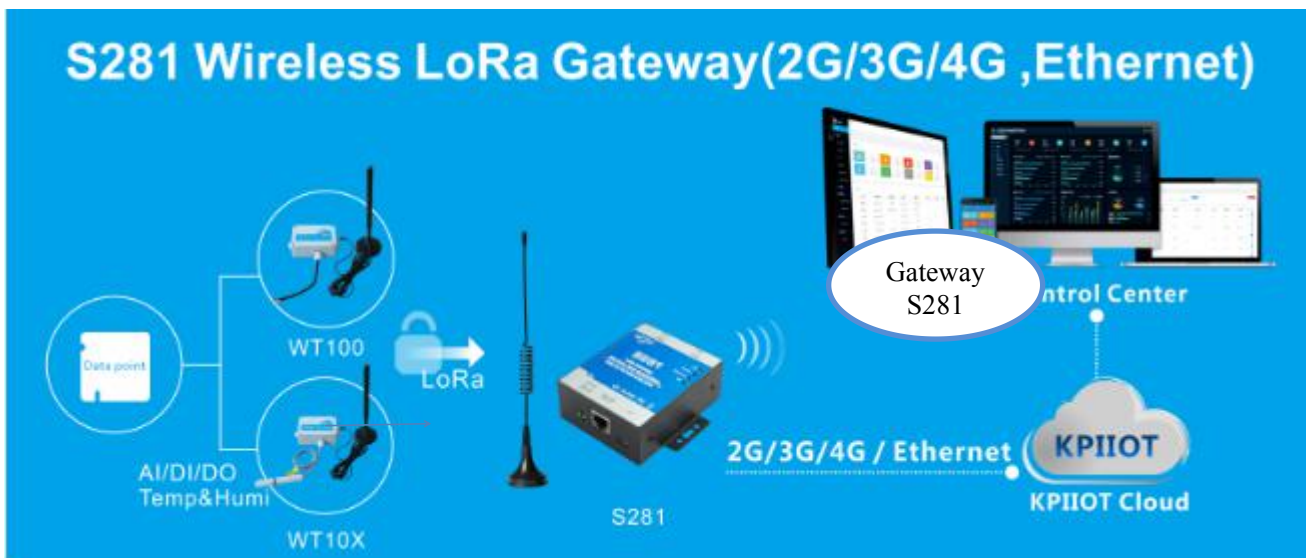

1.2 Typical Application

- Smart agricultural temperature and humidity data acquisition and monitoring.
- Smart breeding temperature and humidity data acquisition and monitoring.
- Smart factory temperature and humidity acquisition and monitoring.
- Other distributed monitoring points.
- ATM、POS、PLC、DAQ and other devices' data transmission.
- Smart grid data transmission.
- Smart traffic data transmission.
- Industrial automation data transmission.
- Environmental protection data transmission.
- Meteorological station Data acquisition and monitoring.
- Data transfer of agriculture, water, coal mines, etc.
- Smart agriculture, smart fire protection, smart city, intelligent building control and other places.
- Other situations where temperature, humidity, and data interaction need to be monitored.

Smart Factory IoT

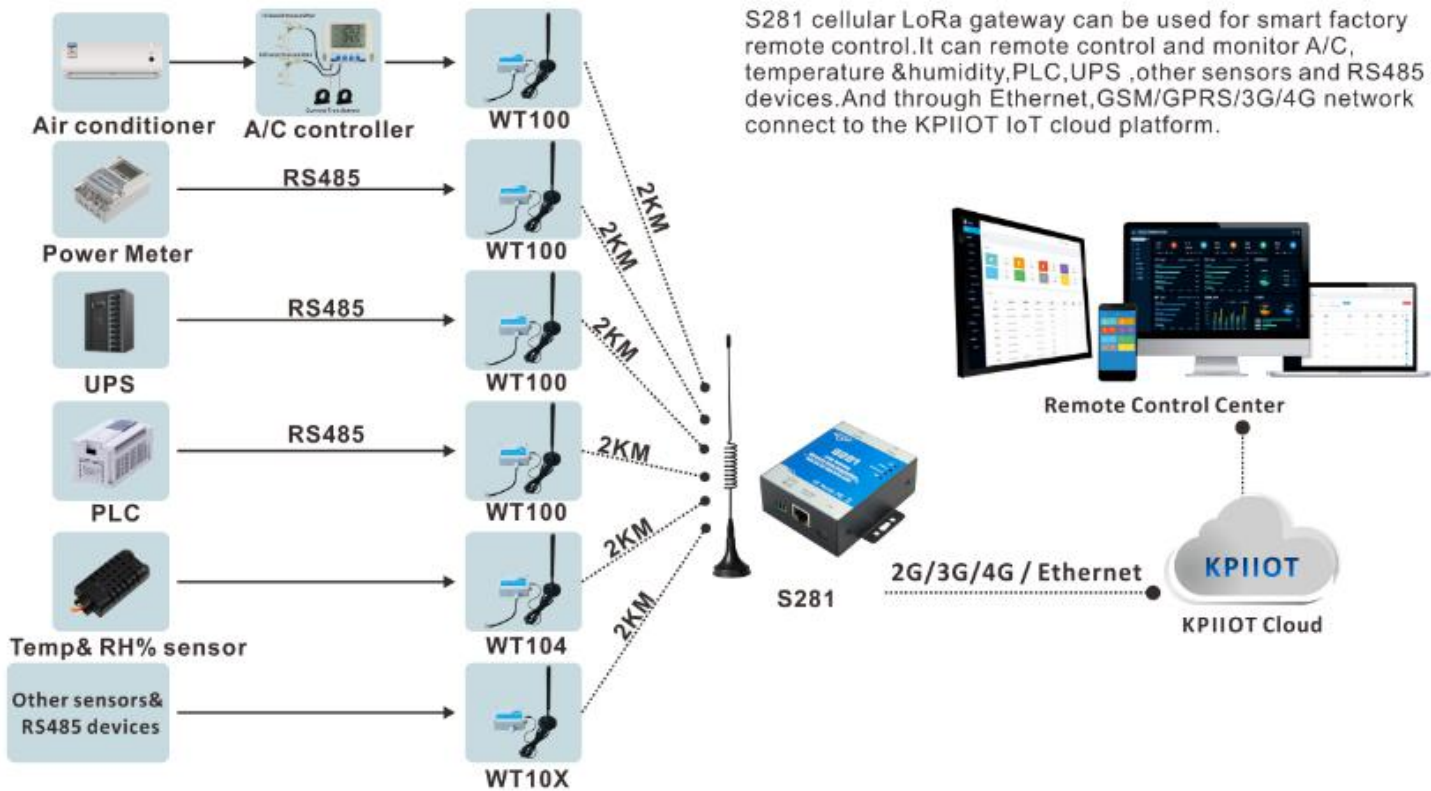

LoRa Temperature & Humidity Monitoring for Chicken Farm & Fridge

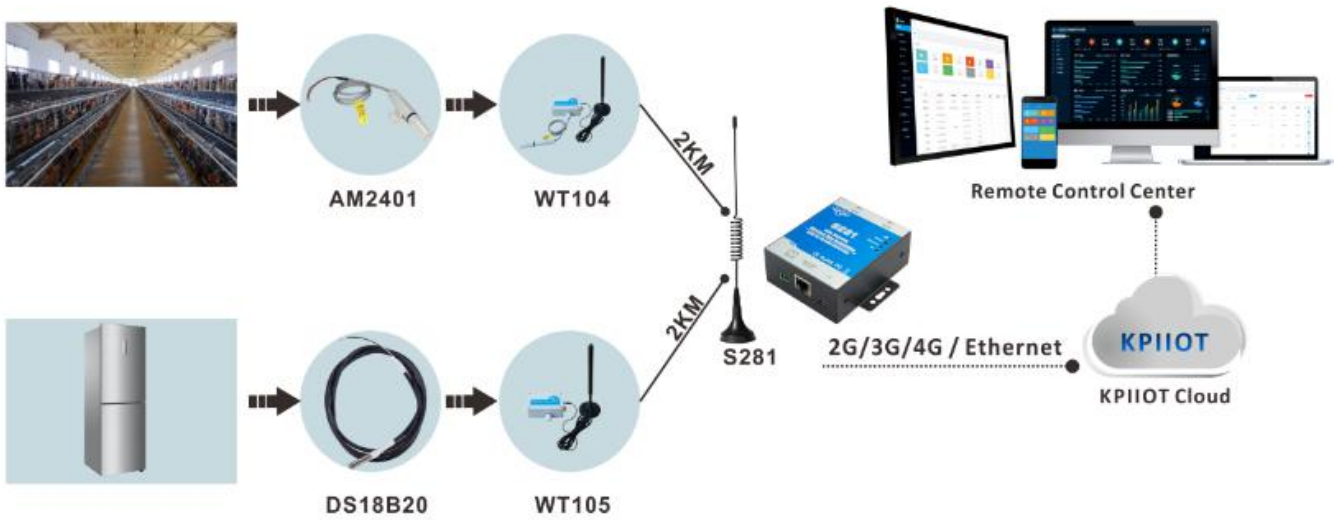

Smart Agriculture IoT

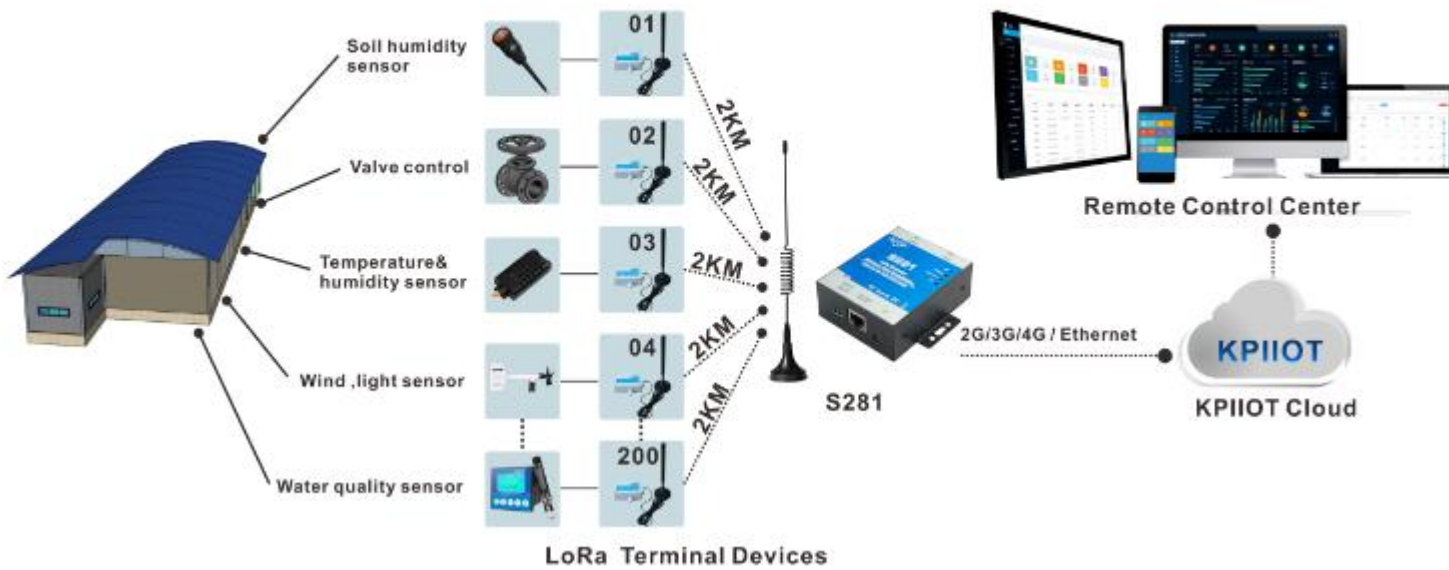

1.3 Packing List

Before install and use S281, pls confirm the contents in box:

- 1) S281 gateway



2) 3.5mm female jack



3) MINI USB cable



4) Adaptor (12VDC-2A, EU/US/UK/AU Plug optional)



5) LoRa Antenna (433MHz)



6) 2G/3G/4G SMA Cellular Antenna



Remark: If anything above missing, pls contact King Pigeon sales.

- Optional accessories: 35mm DIN X2

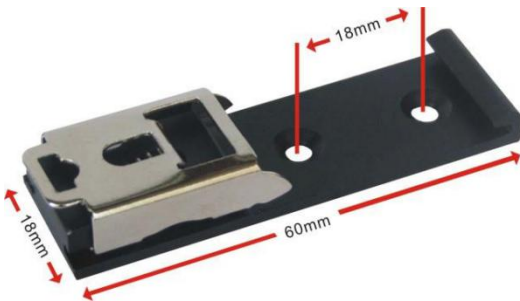

1.4 Features

- Embedded ARM® Cortex™-M4 32-bit RISC core real-time operating system, software watchdog and hardware watchdog to prevent false downtime.
- Wide working voltage design, gateway support 9~36VDC power supply, LoRa sensor support 3.3-24V power supply and with wrong wiring protection design.
- Modular structure design, GSM/3G/4G network upgrade can be upgraded by simply replacing the module.
- Support remote SMS restart device and configure device parameter.
- Through local configuration software, remote SMS, APP to set parameters, easy to operate, easy to use.
- Support 10 user numbers for receiving specific SMS alarm information of device daily report, drop line, serial port data overrun, and abnormal trigger.
- Built-in powerful timer function, support timely automatic report, timely SMS daily report, timely online, timely restart and other functions.
- Modbus TCP protocol and Modbus RTU protocol are compatible with transparent transmission.
- Ethernet transformer isolator, 2KV electromagnetic isolation, housing isolation protection.
- Time-division multiplexing, multichannel mounting, less interference, more mounting nodes, and up to 100 temperature and humidity collection points.
- Real-time monitoring of slave device battery power to ensure that device data is not dropped.



1.5 Gateway Technical Parameter

Item	Parameter	Description
Power	Working Voltage	9~36V DC
	Power Consumption	Normal:130mA@12V,Max:150mA@12V
	Power Protection	Anti wrong wiring,air ESD:15KV,surge:4KV
	Built-in Lithium Battery	3.7V/900mAh,standby time 1-2hrs
USB	USB	1 x mini USB
Network Port	Port Type	1 x RJ45,10/100Mbps
	Port Protection	ESD:8KV, surge:4KV (10/1000us)
LoRa Parameter	Communication Frequency	420MHz-450MHz (can customize 868MHz and 915MHz)
	Indoor Communication Distance	1km
	No Obstacle Communication Distance	2km
	Transmit Power	<24dBm
	Receiving Sensitivity	<-120dBm
	Communication Speed	1.0Kbps
Cellular Network	2G	GSM/EDGE:850,900,1800,1900MHz
	3G	GSM/EDGE:850,900,1800,1900MHz UMTS:850/900/2100MHz
	4G (E)	GSM/EDGE: 900/1800MHz WCDMA:B1,B5,B8 FDD:B1,B3,B5,B7,B8,B20 TDD:B38,B40,B41
	4G (AU)	GSM/EDGE:850/900/1800MHz WCDMA:B1,B2,B5,B8 FDD:B1,B2,B3,B4,B5,B7,B8,B28 TDD:B40
	4G (A)	WCDMA: B2,B4,B5 FDD: B2,B4,B12
	4G (V)	FDD: B4,B13
	4G (J)	WCDMA: B1,B3,B8,B18,B19, B26 FDD: B2,B4,B12 TDD: B41
	4G (CE)	GSM/EDGE: 900/1800MHz WCDMA:B1,B8 TD-SCDMA:B34,B39 FDD: B1,B3,B8 TDD: B38,B39,B40,B41
	SIM/UIM Card	Support 1.8V/3V SIM/UIM,inbuilt 15KV ESD protection
	Software Parameter	Protocol
LED Indicator		Cellular network signal,status,Ethernet,LoRa RF
User Configuration		PC software configuration,support WIN XP、WIN 7、WIN 8,WIN 10
Number of supported nodes		Max 200



	transparent transmission	Support
	Modbus Protocol	Support Modbus RTU/Modbus TCP
	Log in message	Support customized log in message
	Heartbeat message	Support customized Heartbeat message
	Memory	Max can save 2000 history records and 500 alarms
Certificates	MTBF	≥100,000hrs
	EMC	EN 55022: 2006/A1: 2007 (CE &RE) Class B
		IEC 61000-4-2 (ESD) Level 4
		IEC 61000-4-3 (RS) Level 4
		IEC 61000-4-4 (EFT) Level 4
		IEC 61000-4-5 (Surge)Level 3
		IEC 61000-4-6 (CS)Level 4
Others	CE/FCC/ROHS/3C	
Environment	Working Temperature & Humidity	-45~85℃, 5~95% RH
	Store Temperature & Humidity	-45~105℃, 5~95% RH
Others	Enclosure	Metal
	Size	8.8cm×7.5cm×3.0cm(L*W*H)
	IP Level	IP30
	NW	235g
	Installation	Wall-mounted, rail-mounted

2.1 Hardware Illustration

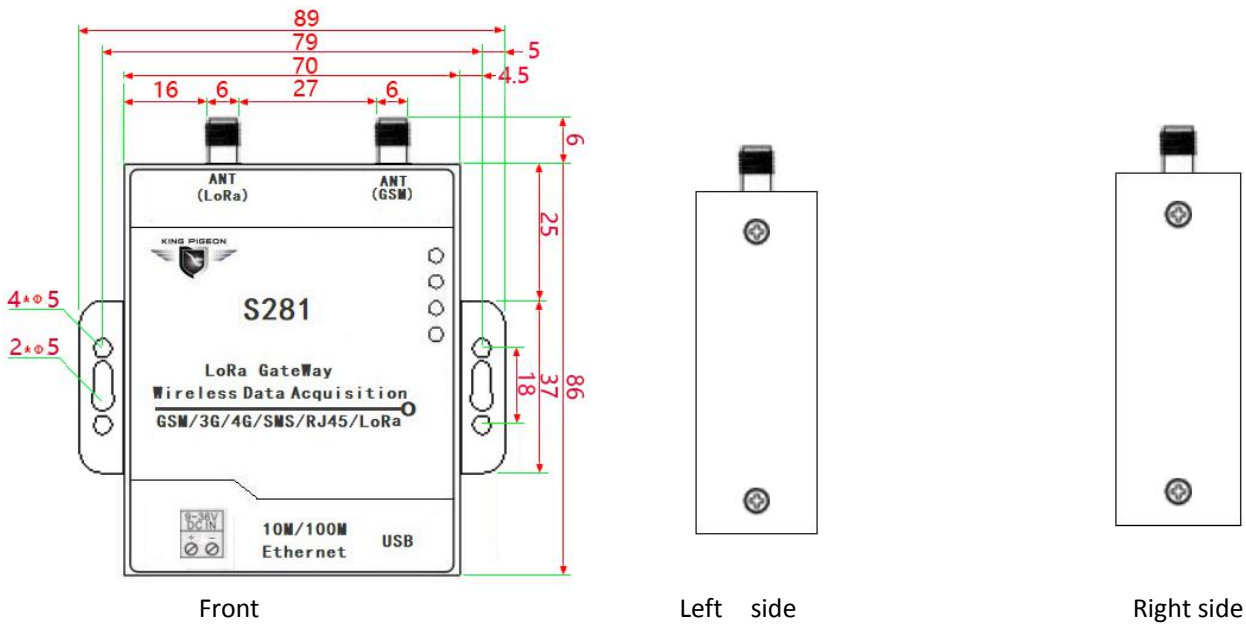

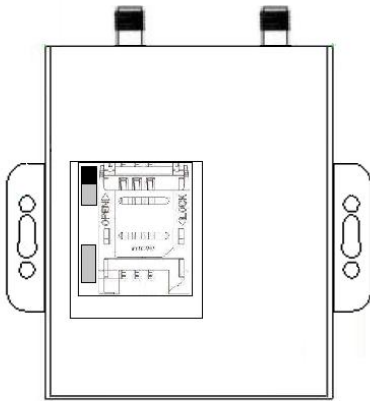

Bottom

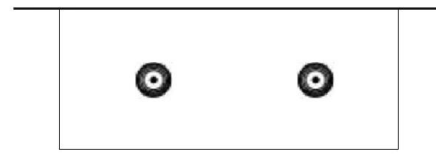

Up

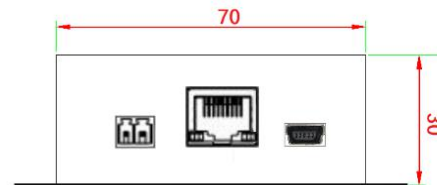

Up

2.2 LED Indicator



LED Indicator			
Name	Color	Status	Description
	Red	Fast flashing	2G:No signal (off 0.8s, on 0.2s) 3G/4G: No signal (off 2S, on 0.2s)
		Slow flashing	2G: Normal(off 2S, on 0.2s); 3G/4G:Normal (off 0.2S, on 2s) ;
		OFF	Device issue
Status	Red	Constantly bright	External power supply is normal
		OFF	External power supply off
Ethernet	Red	Flashing	Data in transmission
		OFF	No data transmission
RF	Red	Flashing	LoRa RF data in transmission
		OFF	LoRa RF data in transmission

2.3 Interface Definition

2.3.1 Power Input



Power Input		
Item	Symbol	Description
1	+	Power input positive
2	-	Power input negative

2.3.2 Ethernet Interface Definition

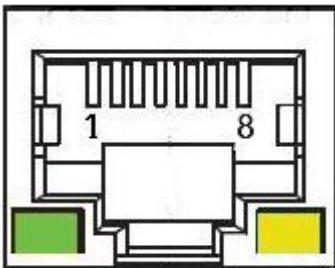

Network Port Description			
Item	568B	Definition	Description
1	Orange white	TX+	Send positive
2	Orange	TX-	Send negative
3	Green white	RX+	Receive positive
4	Blue	Data+	Dual channel data +
5	Blue white	Data-	Dual channel data-
6	Green	RX-	Receive negative
7	Brown white	Data+	Dual channel data +
8	Brown	Data-	Dual channel data-

2.3.3 USB Port

Mini USB connect S281 and PC, set S281 configuration, also can update firmware.



2.3.4 SIM card

S281 support standard 1.8V/3V SIM card

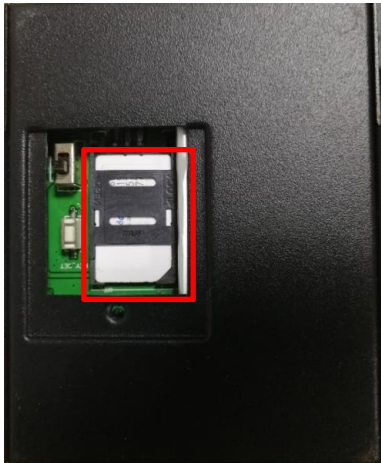

2.3.5 Antenna Interface

S281 has 1* LoRa antenna interface and 1*GSM/3G/4G antenna interface

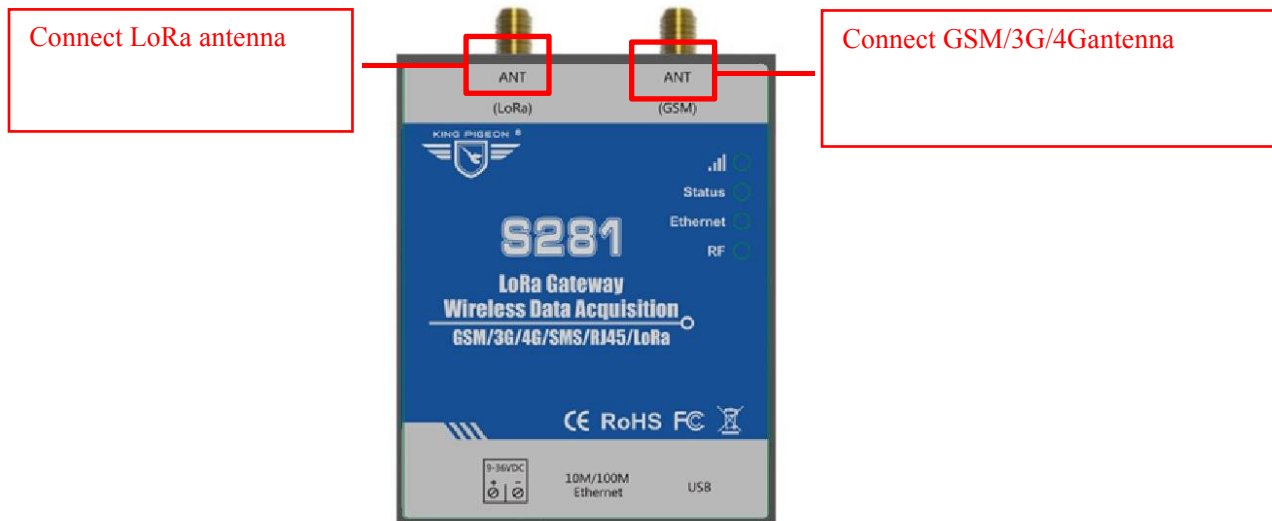

2.4 Installation

S281 supports flat desktop placement, wall mounting and rail mounting.

2.4.1 Wall Mounting



2.4.2 Rail Mounting

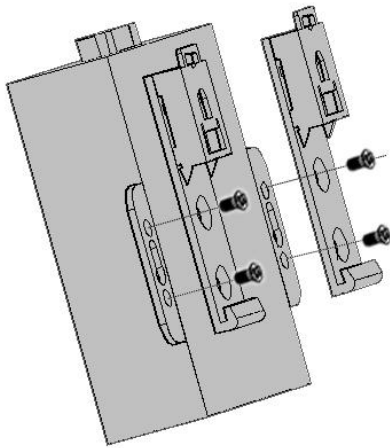

Buckle installation

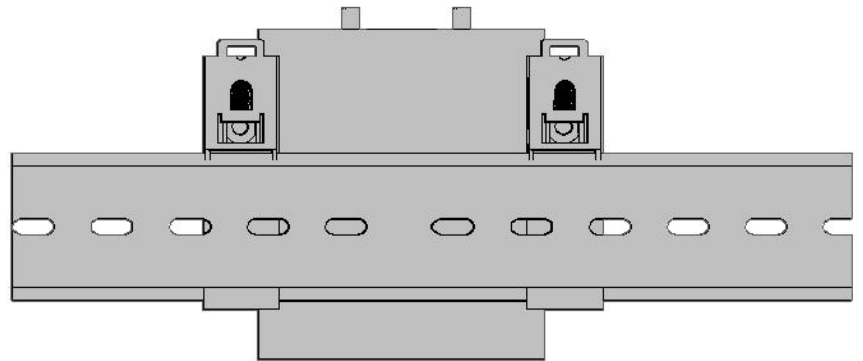

Rail mounting

3.Parameter configuration

S281 software is with a very user-friendly UI design. User can connects the S281 gateway (hereinafter referred to as "gateway") through the USB cable to configure related content, export and load configuration files or firmware upgrade.

3.1 Before Configuration

3.1.1 Install Driver

Skip this step if it is already installed.

Method 1) Download the configuration software and driver files of S281 from the official website of King Pigeon(WWW.4G-IOT.COM), then release the file and install,

Method 2) Download the universal driver, install it on the computer, and then scan the hardware to install the driver.

3.1.2 Find Com Port

Right mouse click [My Computer] and click "Properties > Device Manager > Port". If the connection is normal and the driver is installed properly, the following is displayed (the local port number is COM3):

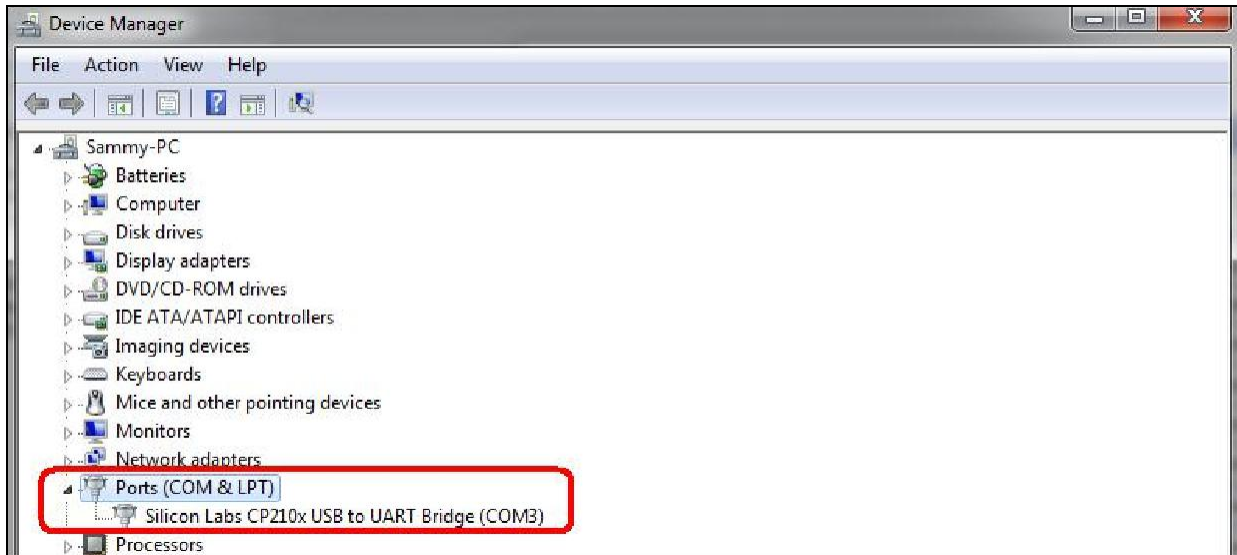



Tips: In some computer, if install the USB driver with problem, please try to get technical supports from technical support page of <http://www.silabs.com> directly.

3.1.3 Log in Configuration Software

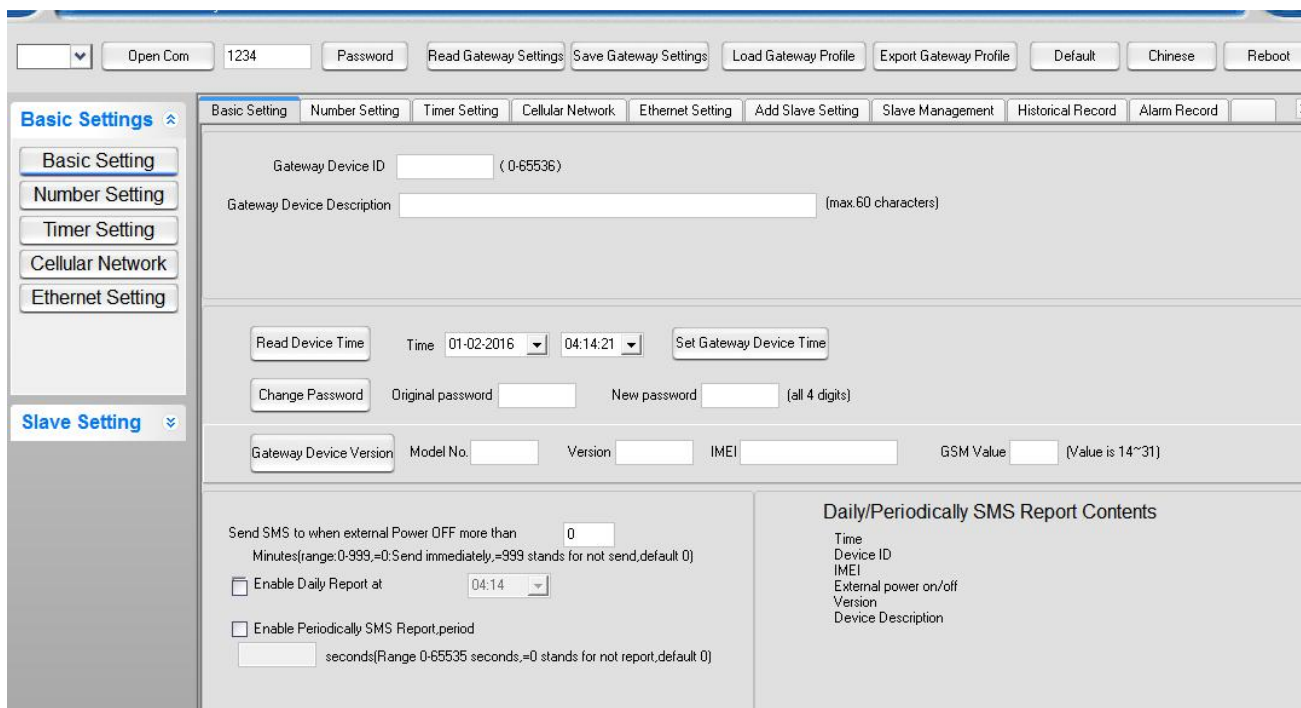

Click  Enter this page :

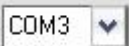

Select connected com port, , COM3, click open com button , Then click the password (the initial password is 1234). If the device is successfully connected, the left bottom will turn green and show “connect successfully”. If the connection is not successful, please verify that the USB connection is good. If the password is incorrectly verified, please check the port number and password.

3.2 Basic setting

Original password: default password is 1234. It is recommended to read the current configuration information before

configuring the parameters, that is, click  and then configure it.

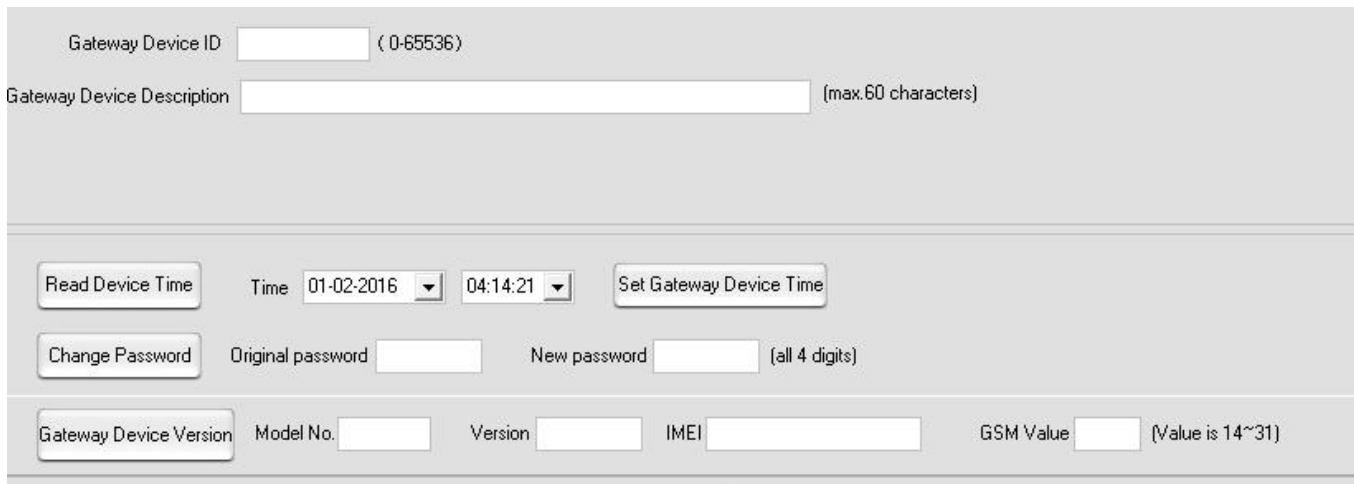

The screenshot shows a configuration interface with the following fields and buttons:

- Gateway Device ID:** Input field with a value of 0-65536.
- Gateway Device Description:** Input field with a limit of (max.60 characters).
- Time:** Two dropdown menus showing 01-02-2016 and 04:14:21, with a **Set Gateway Device Time** button.
- Change Password:** A section with **Original password** and **New password** input fields, with a note (all 4 digits).
- Gateway Device Version:** A section with **Model No.**, **Version**, **IMEI**, and **GSM Value** input fields, with a note (Value is 14~31).

◆ **Gateway Device ID:** The device ID is mainly used to identify the gateway in the monitoring center. Can be freely defined, the range: 0-65536. If the device uses the Modbus protocol, the ID range is fixed at: 1-247, pls note when set.

◆ **Gateway Device Description:** It is description of the master, such as: installation address, instructions for use, etc.



Read current time of gateway device



Write the current time of the computer to the master, then the device will run according to this time

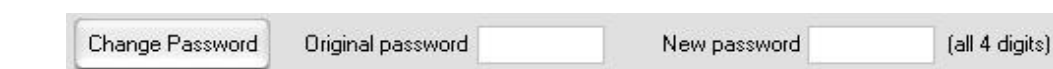

This section contains the **Change Password** button and input fields for **Original password** and **New password** (all 4 digits).

Input new password and save gateway settings.



This section contains the **Gateway Device Version** button and input fields for **Model No.**, **Version**, **IMEI**, and **GSM Value** (Value is 14~31).

◆ **Read Gateway Device Version :** click “Device Version” , then can read device model No, version number, IMEI, and GSM signal values



The device model number and version number are product default information.

◆ **IMEI:** Device identification, every device has only 1 IMEI.

◆ **GSM Value:** The signal strength of the GSM/3G/4G network ranges from 0 to 31. If the reading is always zero, please verify that the SIM installation is secure and if the SIM card charge is overdue.

Send SMS to when external Power OFF more than
Minutes(range:0-999,=0:Send immediately,=999 stands for not send,default 0)

Range: 0~999, unit: minute, if set to 0, immediately report when power is off. Default: Immediate alarm when power is lost.

Enable Daily Report at

Enable Periodically SMS Report, period
 seconds(Range 0-65535 seconds,=0 stands for not report,default 0)

Notice:

The SMS report is reported periodically, and the time point of the SMS report is based on the time set when the device is turned on.

Daily/Periodically SMS Report Contents

- Time
- Device ID:Armed/Disarm
- IMEI
- External power on/off
- Version
- Device Description

The format of daily /periodically SMS report.

Notice:

After setting , please click the "Write Gateway Parameters" button above to save the set value.

3.3 Alarm Numbers Setting

Basic Setting
Number Setting
Timer Setting
Cellular Network
Ethernet Setting
Add Slave Setting
Slave Management
Historical Record
Alarm Re

Basic Settings

Basic Setting

Number Setting

Timer Setting

Cellular Network

Ethernet Setting

Authorized Number Settings

	Alarm Tel Number	All	Timer Report	Alarm	Alarm Recovery	External Power ON/OFF	GPRS Failure	Low GSM Signal
User No.1	<input type="text"/>	<input type="checkbox"/>	<input type="checkbox"/>	<input type="checkbox"/>	<input type="checkbox"/>	<input type="checkbox"/>	<input type="checkbox"/>	<input type="checkbox"/>
User No.2	<input type="text"/>	<input type="checkbox"/>	<input type="checkbox"/>	<input type="checkbox"/>	<input type="checkbox"/>	<input type="checkbox"/>	<input type="checkbox"/>	<input type="checkbox"/>
User No.3	<input type="text"/>	<input type="checkbox"/>	<input type="checkbox"/>	<input type="checkbox"/>	<input type="checkbox"/>	<input type="checkbox"/>	<input type="checkbox"/>	<input type="checkbox"/>
User No.4	<input type="text"/>	<input type="checkbox"/>	<input type="checkbox"/>	<input type="checkbox"/>	<input type="checkbox"/>	<input type="checkbox"/>	<input type="checkbox"/>	<input type="checkbox"/>
User No.5	<input type="text"/>	<input type="checkbox"/>	<input type="checkbox"/>	<input type="checkbox"/>	<input type="checkbox"/>	<input type="checkbox"/>	<input type="checkbox"/>	<input type="checkbox"/>
User No.6	<input type="text"/>	<input type="checkbox"/>	<input type="checkbox"/>	<input type="checkbox"/>	<input type="checkbox"/>	<input type="checkbox"/>	<input type="checkbox"/>	<input type="checkbox"/>
User No.7	<input type="text"/>	<input type="checkbox"/>	<input type="checkbox"/>	<input type="checkbox"/>	<input type="checkbox"/>	<input type="checkbox"/>	<input type="checkbox"/>	<input type="checkbox"/>
User No.8	<input type="text"/>	<input type="checkbox"/>	<input type="checkbox"/>	<input type="checkbox"/>	<input type="checkbox"/>	<input type="checkbox"/>	<input type="checkbox"/>	<input type="checkbox"/>
User No.9	<input type="text"/>	<input type="checkbox"/>	<input type="checkbox"/>	<input type="checkbox"/>	<input type="checkbox"/>	<input type="checkbox"/>	<input type="checkbox"/>	<input type="checkbox"/>
User No.10	<input type="text"/>	<input type="checkbox"/>	<input type="checkbox"/>	<input type="checkbox"/>	<input type="checkbox"/>	<input type="checkbox"/>	<input type="checkbox"/>	<input type="checkbox"/>

Notice:

1、Tick the options and SMS will be sent to the alarm numbers after the event occurs.
 2、Low GSM Signal: GSM value is less than 14,full is 31.

Alarm Tel Numbers: Set the alarm receiver numbers, please includes the country code, e.g. in China is 0086, so input 8613570810254 neither +8613570810254 nor 008613570810254. Also, some GSM/3G Operators not required input country code, so please remove country code, e.g. in China is 0086, and China Mobile not required country code, so can set as 13570810254.

Timer Report: Tick it stands for Timer report SMS will send to this number.

Alarm/Alarm Recovery: Tick it stands for while alarm or recovery, will send SMS to this number.

External Power ON/OFF: Tick it stands for while external DC Power loss will send SMS to this number.

GPRS Failure: Tick it stands for while GPRS/3G/4G connection re-try 3 times and still failure will send SMS to this number.

Low GSM Signal: Tick it stands for while GSM or 3G/4G Network signal strength lower than 14 will send SMS to this number.

Notice:

After setting , please click the "Save Gateway Parameters" button above to save the set value.

3.4 Timer setting

This interface is to perform the corresponding operation at a specific time point. A total of 10 timed events can be set.



Basic Settings | Number Setting | **Timer Setting** | GPRS Setting | Ethernet Setting | Add Slave Setting | Slave Manager | Historical Record | Alarm Record

Notice: Tick it stands for Enable the Timer, otherwise will be invalid

Enable/Disable	Week	Hour	Minute	Action
<input type="checkbox"/>	Monday	0	0	0.Reboot
<input type="checkbox"/>	Tuesday	0	0	1.Auto Report By SMS
<input type="checkbox"/>	Everyday	0	0	0.Reboot
<input type="checkbox"/>	Sunday	0	0	0.Reboot
<input type="checkbox"/>	Sunday	0	0	0.Reboot
<input type="checkbox"/>	Sunday	0	0	0.Reboot
<input type="checkbox"/>	Sunday	0	0	0.Reboot
<input type="checkbox"/>	Sunday	0	0	0.Reboot
<input type="checkbox"/>	Sunday	0	0	0.Reboot
<input type="checkbox"/>	Sunday	0	0	0.Reboot
<input type="checkbox"/>	Sunday	0	0	0.Reboot
<input type="checkbox"/>	Sunday	0	0	0.Reboot

- ◆ **Week:** Set Monday to Sunday or every day.
- ◆ **Action:** The specific action that is performed at the set time.

Notice:
After setting, please click the "Write Gateway Parameters" button above to save the set value.

3.5 Cellular Network Setting

This Page is for set the Cellular communication parameters, Cellular network Transmit data protocol and Server information. Only when you have Server or need to use cellular network to transmit data then to set these parameters.

Basic Settings | Number Setting | Timer Setting | **Cellular Network** | Ethernet Setting | Add Slave Setting | Slave Management | Historical Record | Alarm Record

Cellular Communication: 0.Disable

Access Point Name:

Cellular Network User Name:

Cellular Network Password:

Target Server

Server IP Address:

Server Port:

Protocol: TCP

Heartbeat Interval Time: 60 (0-65535seconds, default 60)

Idle Offline Re-connection Time: 120 (0-65535seconds, default 120)

Re-connection time if no response: 3 (1~9times, default 3)

Reconnection Interval Time: 600 (0-65535seconds, default 600)

Login Message: Tick for HEX format

Login ACK Message: Tick for HEX format

Logout Message: Tick for HEX format

Heartbeat message: ACK Tick for HEX format

Heartbeat ACK Message: Tick for HEX format

Login Message Strategy:

GPRS/3G/4G communication for Debug

Data received from server:

Data send to server:

Debug ON

Debug OFF

Clear

Cellular Network Access Network Configuration:



Communication option: 0 Prohibited: (Disable cellular network)
1 Enable: (Enable cellular network)

Enable cellular network, Modbus TCP and Modbus RTU, transparent transmission can be used at the same time.

APN(Access Point Name), user name, user password: SIM card Internet access parameters, if the customer SIM can not access the Internet, you can consult the local network operator, fill in the corresponding parameters

Protocol: TCP/UDP

→ **Connect Target Server :**

Server domain or IP: Pls fill in domain or IP

Server port: The target server monitoring port.

The cellular network transmits data to the server: you can fill in server info to read the data. You can also access the **King Pigeon Cloud V3.0 platform (www.kpiiot.com)**. When connecting to our platform, the configuration are as follows. Domain name: **modbusrtu.kprtu.com** Port: **4000**.

→ **Data transmission specification configuration :**

Heartbeat Interval Time: The period time of the device sends data to the master when the user adopts self-defined protocol. Range: 0-65535, unit: second, default: 60

Idle Offline Re-connection Time: The device go online again after dropped. Range: 0-65535, unit: second, default: 60.

Re-connection times if no response : Reconnect after the device dropped, limited the times of the server Connecting. If it is not connected to the server within the limited times,the cellular network module will automatically restart.

Login Message: The device ID sent by the device to the server to confirm the device information. If you want to access **King pigeon Cloud V3.0 platform (www.KPIIOT.com)**, please contact **King pigeon to get a registration code**.

Login ACK Message: Confirmation data that the server feeds back to the device.

Logout Message: A confirmation online data sent by the device to the server.

HeartbeatMessage :self-defined command word that periodically notifies the other party's own state between the client and the server, and sends it at a certain interval.

Heartbeat ACK Message: Heartbeat response message.

Login Message Strategy: registration package sending method.

Data transmission: The user needs to fill in the contents of the Login Message,Login ACK Message,registration response packet, heartbeat packet, heartbeat response packet, and offline packet according to the cloud platform data transmission rule used. KingPigeon KPIIOT cloud platform can be used simply by filling in the registration package and heartbeat package, and the registration policy is sent once at startup.

Tips:

After setting, please click the “Save gateway Setting” button above to save the set value.

3.6 Ethernet Setting



Basic Settings Basic Setting Number Setting Timer Setting Cellular Network **Ethernet Setting** Add Slave Setting Slave Management Historical Record Alarm Record

Basic Setting
Number Setting
Timer Setting
Cellular Network
Ethernet Setting

Slave Setting

Ethernet Communication Protocol: 0.Disable | Ethernet Communication Protocol: TCP

Local IP: port:

Subnet mask:

Gateway IP:

DNS IP1: 5 . 5 . 5 . 5

DNS IP2: 5 . 5 . 5 . 5

Target server
Server IP Address:
Server Port:

Heartbeat Interval Time: 60 (0-65535Seconds,default 60)
Idle Offline Re-connection Time: 120 (0-65535Seconds,default 120)
Re-connection time if no response: 3 (1~9times,default 3)

Login Message: Tick for HEX format
Login ACK Message: Tick for HEX format
Logout Message: Tick for HEX format
Heartbeat message: ACK Tick for HEX format
Heartbeat ACK Message: Tick for HEX format
Login Message Strategy: 0.Send Once When Login Serv

Ethernet Data communication for Debug
Data received from server: Data send to server:

Debug ON
Debug OFF
Clear

3.6.1 Local Network Setting :

- ◆ **Ethernet Communication:** 1 Enable ethernet communication function.
0 Disable ethernet communication function.
- ◆ **Transmission protocol:** TCP/UDP, pls choose according to your requirements.
- ◆ **Local IP and port:** pls fill in according to the actual situation. (Cannot conflict with other IP addresses and ports in the network)
- ◆ **Subnet mask:** pls fill in according to the actual situation.
- ◆ **DNS IP 1:** pls fill in according to the actual situation.
- ◆ **DNS IP 2:** pls fill in according to the actual situation.

The local network configuration can be obtained automatically when the local IP address is filled in with 0.0.0.0 (the device port number needs to be filled in manually). This device can be used as a TCP server or as a TCP client.

Connect to Target Server :

→ Connect Target Server :

- ◆ **Server domain or IP:** pls fill in domain or IP
- ◆ **Server port:** The target server monitoring port.

The ethernet network transmits data to the server: the customer can fill in server info to read the data. You can also access the **King Pigeon Cloud V3.0 platform (www.kpiiot.com)**. When connecting to our platform, the configuration are as follows. Domain name: **modbusrtu.kprtu.com** Port: **4000**.

3.6.2 Data transmission specification configuration :

Heartbeat Interval Time: The period time of the device sends data to the master when the user adopts self-defined protocol. Range: 0-65535, unit: second, default: 60

Idle Offline Re-connection Time: The device go online again after dropped. Range: 0-65535, unit: second, default: 60.

Re-connection times if no response : Reconnect after the device dropped, limited the times of the server Connecting. If it is not connected to the server within the limited times, the cellular network module will automatically restart.

Login Message: The device ID sent by the device to the server to confirm the device information. If you want to access **King pigeon Cloud V3.0 platform (www.KPIIOT.com)**, please contact **King pigeon to get a registration code**.

Login ACK Message: Confirmation data that the server feeds back to the device.

Logout Message: A confirmation online data sent by the device to the server.

HeartbeatMessage : self-defined command word that periodically notifies the other party's own state between the client and the server, and sends it at a certain interval.

Heartbeat ACK Message: Heartbeat response message.

Login Message Strategy: registration package sending method.

Data transmission: The user needs to fill in the contents of the Login Message, Login ACK Message, registration response packet, heartbeat packet, heartbeat response packet, and offline packet according to the cloud platform data transmission rule used. KingPigeon KPIIOT cloud platform can be used simply by filling in the registration package and heartbeat package, and the registration policy is sent once at startup.

Tips: After setting , please click the "Save gateway Setting" button above to save the set value.

3.7 Add Slave Device

3.7.1 Slave Device Spec

WT100 (RS485 Data Transparent Transmit Device)



Introduction:

WT100 remote terminal device is a micro power wireless data transmission module. Based on LoRa spread spectrum modulation technology, half duplex communication. There is a self-contained transceiver program in the MCU. Users can realize transparent transmission of data (issued and received) without changing the user data and protocol. Customers do not need to configure, easy to operate.

WT100 remote transmission terminal device can connect the RS485 serial port device or RS485 sensor to the S281 gateway and the cloud, and transmit the devices or sensors data to the cloud. Can use many WT100 as group networks. The gateway S281 can collect data of RS485 Sensors or devices which connected to WT100 via RS485. Commonly used in remote meter reading, access control systems, wireless data communications, industrial data acquisition, wireless remote telemetry, security systems, robot control and other fields.

Features:

Wide voltage DC power supply, supports 3.3V ~ 24V.

Adopting efficient forward error correction coding technology and frequency hopping mechanism, strong anti-interference ability and low error rate.

Communication parameters can be flexibly configured according to requirements.

Receive sensitivity up to -148dBm, maximum transmit power +20dBm

Interface anti-electromagnetic interference design to ensure that RS485 data is normal.

Item	Parameter
Wire Definition	1pin Red: Power+
	2pin Black: Power—

	3pin Blue: RS485+
	4pin Yellow: RS485-
	5pin White: GND
Power Supply	DC 3.3V~24V
Power Consumption	Standby 30mW, data transmit and receive 500mW
Serial Port	Baud rate:9600, Parity:8,none,1;(Adjustable)
Working Mode	Transparent transmit (can realize many WT100 units mutual transmit)
Serial port buffer	200 bytes
Working Frequency	420MHz~450MHz (Other frequency can be customized)
Working Environment	Temperature: -10~+70℃; Humidity: ≤95%;
LoRa Antenna	External SMA 433MHz antenna
Communication Distance	2km (No obstacle)
Waterproof Level	IP65
Size	101mmX69mmX39mm
Packing List	WT100x1,12V charger x1; LoRa antenna x1

RSSI support, the signal value can be viewed through the gateway.

WT104 (Wireless LoRa Temperature&Humidity Slave Device)



WT104 remote terminal device is a high-performance, low-power, long-distance wireless LoRa terminal that must be used with the S281 gateway. It is mainly used to monitor the environment temperature and humidity, and actively upload the data to the S281 LoRa gateway. It is with imported sensor core, meets the WMO World Meteorological Organization specifications, widely used in meteorology, environment, agriculture, aquaculture, warehouses, etc

Features:

LoRa protocol, simple, secure and reliable.

The operating parameters and alarm parameters can be configured through the S281 configuration software.

low power-consumption mode. Usually in a dormant state, periodically wake up to report data.

If alarm is triggered ,can directly wake up to send the alarm data in 10S.

Smart transmission mechanism adjusts the next transmission time according to the signal of the device after the channel collision.

The current value of the battery voltage can be sent to prevent data loss caused by battery power failure.

Item	Parameter
Temperature Measurement range	-40~+80℃,accuracy: ±0.3℃
Humidity Measurement range	0~100%RH, accuracy: ±4.5%
Working Mode	Timed wake up for active reporting
Working Frequency	420MHz~450MHz (other frequency can be customized)
Power Supply	3* AAA (3.3V~5V)
Power Consumption	≤0.24Mw@5V during sleep, ≤500Mw@5V during working
LoRa Antenna	External SMA 433HMZ antenna
Communication Distance	2km (No obstacle)
Waterproof Level	IP65
Size	101mmX69mmX39mm
Installation	Wall-mounted,flat placed
Packing List	WT104x1; LoRa Antenna x1

WT105 (DS18B20 Temperature Logger)



The WT105 uses the DS18B20 sensor. The DS18B20 is a commonly used digital temperature sensor with small size, low cost, strong anti-interference ability and high precision. The packaged DS18B20 can be used for cable trench temperature measurement, blast furnace water cycle temperature measurement, boiler temperature measurement, server room temperature measurement, agricultural greenhouse temperature measurement, clean room temperature measurement, ammunition library temperature measurement and other non-limit temperature occasions. Wear-resistant and impact-resistant, small size, easy to use, and various package types, suitable for digital temperature measurement and control in various narrow space devices.

Features:

LoRa protocol, simple, secure and reliable.

The operating parameters and alarm parameters can be configured through the S281 configuration software.

low power-consumption mode. Usually in a dormant state, periodically wake up to report data.

If alarm is triggered ,can directly wake up to send the alarm data in 10S.

Smart transmission mechanism adjusts the next transmission time according to the signal of the device after the channel collision.

The current value of the battery voltage can be sent to prevent data loss caused by battery power failure.

Item	Parameter
Temperature Measurement Range	-40~+80℃, Accuracy: ±0.3℃
Working Mode	Timed wake up for active reporting
Working Frequency	420MHz~450MHz (other frequency can be customized)
Power Supply	3* AAA (3.3V~5V)
Power Consumption	≤0.24Mw@5V during sleep, ≤500Mw@5V during working
LoRa Antenna	External SMA 433HMZ antenna
Communication Distance	2km (No obstacle)
Waterproof Level	IP65
Size	101mmX69mmX39mm
Installation	Wall-mounted,flat placed
Packing List	WT105x1,LoRax1

WT106 (PT100 Temperature Logger)

Product description:

PT100 with PT100 thermal resistance is a widely used temperature measuring element, which has unparalleled advantages of any other temperature sensor in the range of -50 ℃ ~ 600 ℃, including high precision, good stability, strong anti-interference ability, etc. . The PT100 sensor can sense the temperature and convert it into an analog signal. It has certain applications in the fields of industry, electronics, machine tools, metallurgy, petroleum, chemical and other fields.

The device has been calibrated with high precision when it leaves the factory. If the temperature needs to be recalibrated due to sensor replacement and other reasons, you can check the WT106 temperature calibration document to recalibrate the device.

Features:

LoRa private protocol, simple, secure and reliable;

Working parameters and alarm parameters can be configured through S281 configuration software.

Adopting two working modes, normal working mode and low power consumption mode, automatically switching according to voltage

In low power consumption mode, an alarm can be triggered within 10 seconds to report the alarm data directly;

Alarms can be reported directly in normal working mode

Intelligent transmission mechanism, adjust the next transmission time according to its own device number after a channel collision;

Can send the current value of battery voltage to prevent data loss caused by battery power failure.

Item	Parameter
Temperature Measurement Range	-50~+200°C, Accuracy: ±0.2°C
Working Mode	Timed wake up to active reporting(Voltage ≤ 6V) Normal working mode(voltage ≥ 6V)
Working Frequency	420MHz~450MHz (other frequency can be customized)
Power Supply	3* AAA (3.3V~5V)
Power Consumption	≤0.24Mw@5V during sleep, ≤500Mw@5V during working
LoRa Antenna	External SMA 433HMZ antenna
Communication Distance	2km (No obstacle)
Waterproof Level	IP65
Size	101mmX69mmX39mm
Installation	Wall-mounted,flat placed
Packing List	WT106x1,LoRax1,12V power adapter(optional)

3.7.2 Add slave device and set

1.Open the slave device and power on.



WT100



WT104/105/106

2.LED indicator:

D1: Configuration mode:After power on,enter pre-configuration mode (keep shining for 10s),if not receive configuration data,then enter work mode with previous setting.If set successfully,then it will be off ,then shiny for1 s,and then off,enter working mode.



D1: working mode(Every 8S shines 1 time)

D2 :data transmit

3.Open configuration software.

The screenshot shows the configuration software interface. The 'Basic Settings' tab is active, showing options for 'Basic Setting', 'Number Setting', 'Timer Setting', 'Cellular Network', 'Ethernet Setting', 'Add Slave Setting', 'Slave Management', 'Historical Record', and 'Alarm Record'. The 'Slave Setting' tab is also visible, showing options for 'Add Slave', 'Slave Management', 'Historical Record', and 'Alarm Record'. The main configuration area is for 'Slave WT104', with fields for 'Working frequency', 'Slave Serial' (set to 1), and 'Active upload interval' (set to 0 min). There are buttons for 'Read WT104 Setting', 'Save WT104 setting', 'Export WT104 setting as XML', and 'Load WT104 setting'. A table below shows configuration parameters for Temperature and Humidity. The 'Slave WT100' section is also visible, with fields for 'Slave Device Serial', 'Baudrate', 'Data bit', 'Parity Bit', and 'Stop Bit'. A 'Notice' section provides instructions for slave configuration.

Type	Channel	Maximun	Minimun	Threshold High	Threshold Low	High Alarm SMS	Low Alarm SMS	Recovery SMS Conte	Enable Recover
Temperature		80	-40	0	0				<input type="checkbox"/>
Humidity		100	0	0	0				<input type="checkbox"/>

- ◆ **Working frequency band:** Select the communication frequency band between the gateway and the slave terminal device. (The gateway and slave terminal devices need to communicate on the same network. When there are multiple gateway devices, you need to select different network numbers.)

Currently,we have slave device WT100 and WT104.

3.7.3 Add WT104 (Temperature&Humidity Acquisition Slave Device)

&WT105&WT106

Follow the steps below to add the WT104/WT105 slave terminal device.

Select the working frequency,and save gateway setting.

Fill in the configuration information of WT104 on the configuration software

This screenshot is a zoomed-in view of the 'Slave WT104' configuration section. It shows the 'Working frequency' field, the 'Slave Serial' dropdown menu set to '1', and the 'Active upload interval' dropdown menu set to '0 min'. Below these are buttons for 'Read WT104 Setting', 'Save WT104 setting', 'Export WT104 setting as XML', and 'Load WT104 setting'. The table from the previous screenshot is also visible, showing the configuration for Temperature and Humidity.

- ◆ **Slave Serial:** Slave device address (range: 1-100)
- ◆ **Active upload interval:** The time interval for the terminal to report automatically, which can be selected according to the drop-down box. Minimum 5min, maximum 4h.
- ◆ **Input type:** temperature and humidity are fixed, the first channel is temperature, and the second

channel is humidity.

◆ **Channel name:** It is filled in according to the way of use, and the terminal alarm is used when sending text messages. The content can be up to 40 bytes in length.

◆ **Maximum minimum:** fixed, temperature measurement range: -40-80°C, humidity measurement range: 0-99% RH. This can be ignored by the user during configuration.

◆ **High Threshold alarm value:** the current value of the channel exceeds this value and is considered as the high limit alarm.

◆ **Low Threshold alarm value:** the current value of the channel is lower than this value and is considered as the low limit alarm.

◆ **High-Threshold alarm SMS content, low-Threshold alarm SMS content, recovery SMS content:** alarm and recovery, send SMS content to customers, each SMS content length supports 40 contents. The default is: high limit alarm, low limit alarm, recovery.

◆ **Enable Recovery SMS :** When device alarm status is restored, set the device sends a recovery SMS or not.

Configure LoRa Slave

Steps:

1. Power on slave device, it will stay in pre-configuration mode for 10 seconds, signal light keeps on.
2. During pre-configuration mode, click "save WT100 Settings".
3. If slave's signal light off, means not receive configuration data.
4. If configuration data is updated, signal light will be on for 1s, then off, and enter working mode

with new configuration data.

Note: When configure WT104/WT105/WT106 not successfully, and need re-configure, must power off WT104/WT105/WT106 and

wait for 20s, then can power on and configure. Because the device has very low power-consumption, after power off device, still need wait 20s till power on PCB is used up.

"Slave Management" is mainly for WT104 /WT105 configuration and current value. WT100 slave is data transparent transmission, so "slave management" no WT100.

Load and export slave WT104/WT105/WT106 configuration information



If you need to write the current WT104 parameter in other slave device (same model), you can use these two buttons to copy and save settings of device configuration.

3.7.4 Add WT100 (RS485 Transparent transmission slave device)

Follow the steps below to add the WT100 slave terminal device.

- 1) Select the working frequency, and save gateway setting.
- 2) Fill in the configuration information of WT100 on the configuration software

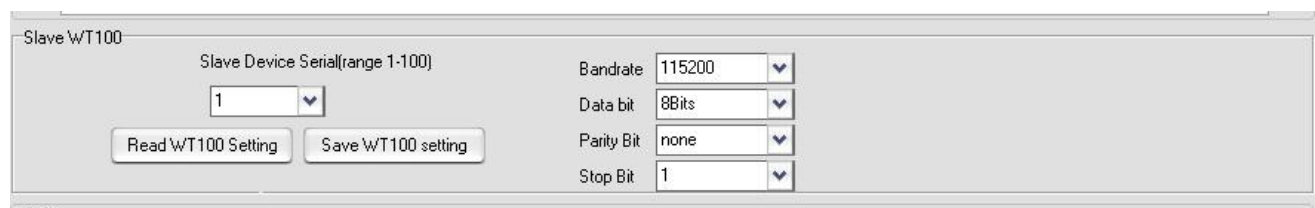

◆ **Slave serial NO:** Device address of the terminal (range: 1-100)

◆ **Baud rate:** 1200-115200 is optional, choose according to the actual situation, default: 9600.

- ◆ **Data Bit:** Support 8, 9, Default: 8
- ◆ **Parity Bit:** support none, even, odd, default: none
- ◆ **Stop Bit:** Support 1 and 2, default: 1

Notice: The serial port settings need to be filled in according to the settings of the connected RS485 device.

Steps:

1. Power on slave device, it will stay in pre-configuration mode for 10 seconds, signal light keeps on.
2. During pre-configuration mode, click "save WT100 Settings".
3. If slave's signal light off, means not receive configuration data.
4. If configuration data is updated, signal light will be on for 1s, and enter working mode with new configuration data.

Notice: After changing the working frequency band, you need to click the [save Gateway Parameters] button above to save the data and then start adding terminals.

3.8 Manage Slave Device

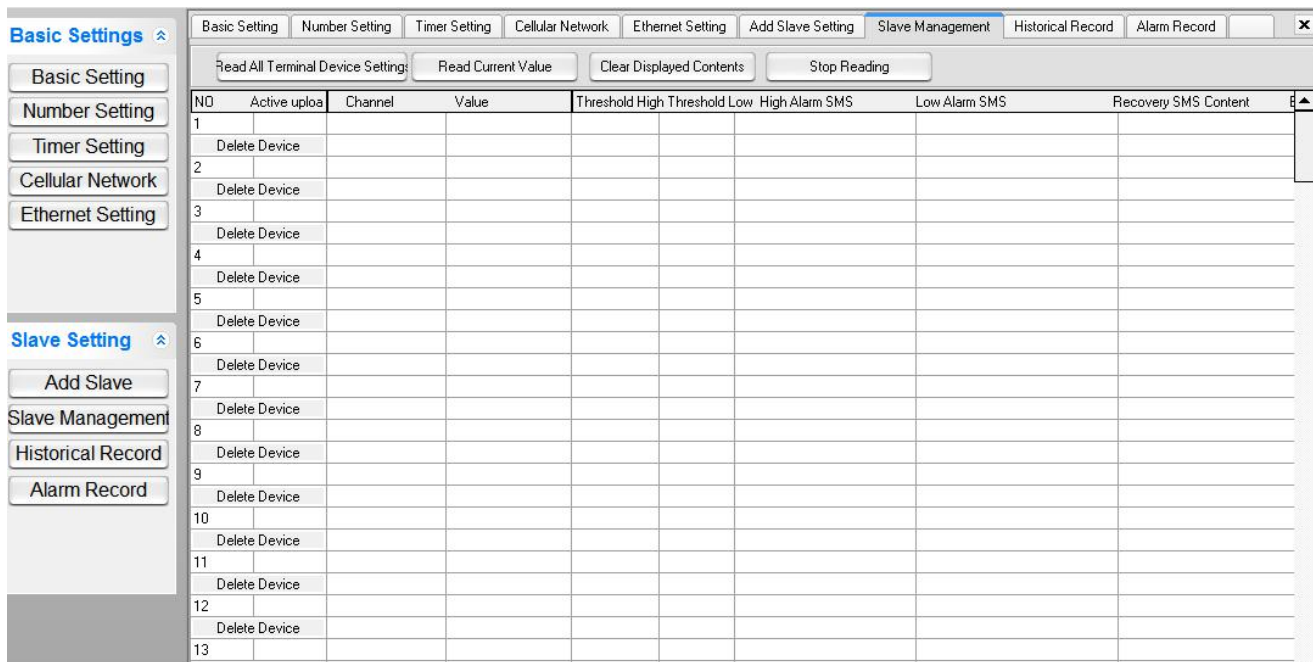

The picture above shows the current status page of the terminal WT104 that has been configured. User can view the current information of the register on this page.

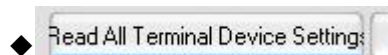

Click this button to read all the terminal configuration information that has been configured.

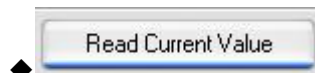

Click this button to read the current value of each channel of the terminal.

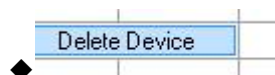

Because the working mode of the slave device is active upload, the data of the gateway cannot be received. Therefore, the "delete configuration" can only change the upload interval to 0, making it unable to alarm.

3.9 History Record

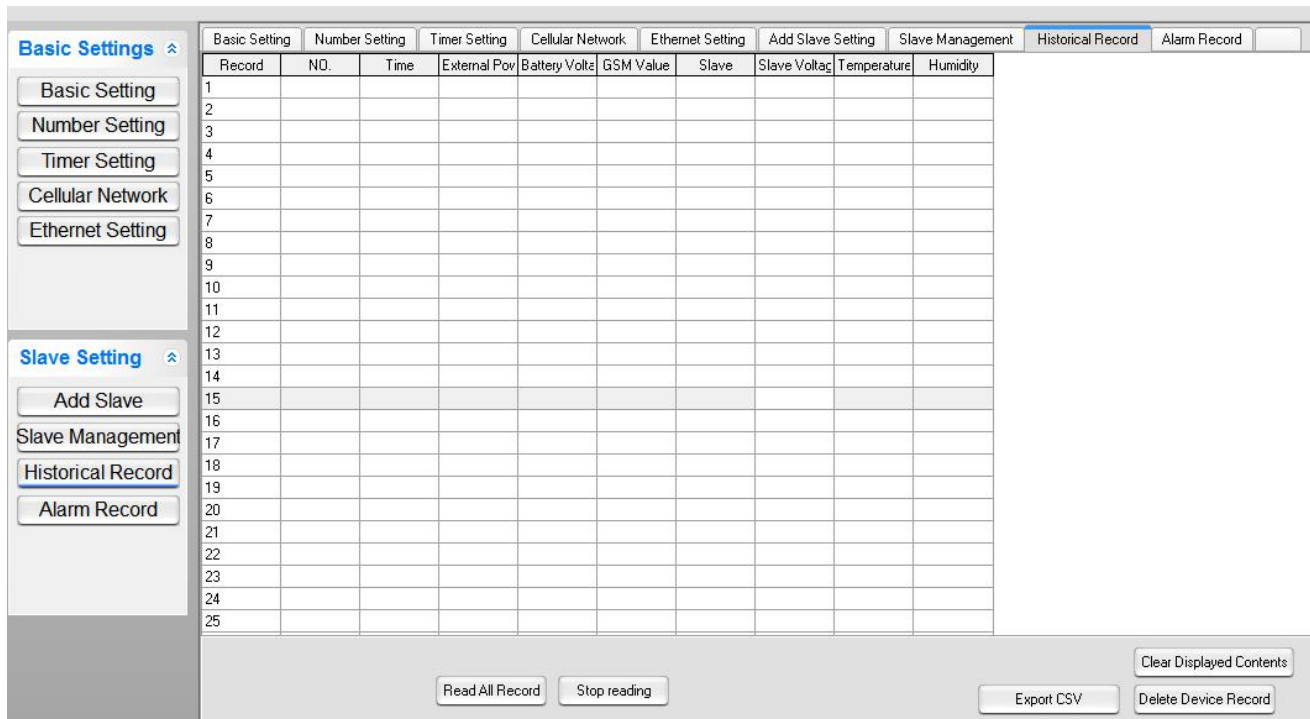

Record	NO.	Time	External Power	Battery Voltage	GSM Value	Slave	Slave Voltage	Temperature	Humidity
1									
2									
3									
4									
5									
6									
7									
8									
9									
10									
11									
12									
13									
14									
15									
16									
17									
18									
19									
20									
21									
22									
23									
24									
25									

The above picture shows the history record form .2000 history records can be saved and read.

- ◆ **Read all records:** display all history in the table.
- ◆ **Stop reading:** You can stop the reading process at any time.
- ◆ **Clear displayed content:** Empty the contents of the current form
- ◆ **Export CSV:** Export the contents of the table to a file in .XML format.
- ◆ **Delete device records:** Delete all the history records and alarm records of the device, and start recording again from the first one.

3.10 Alarm Record

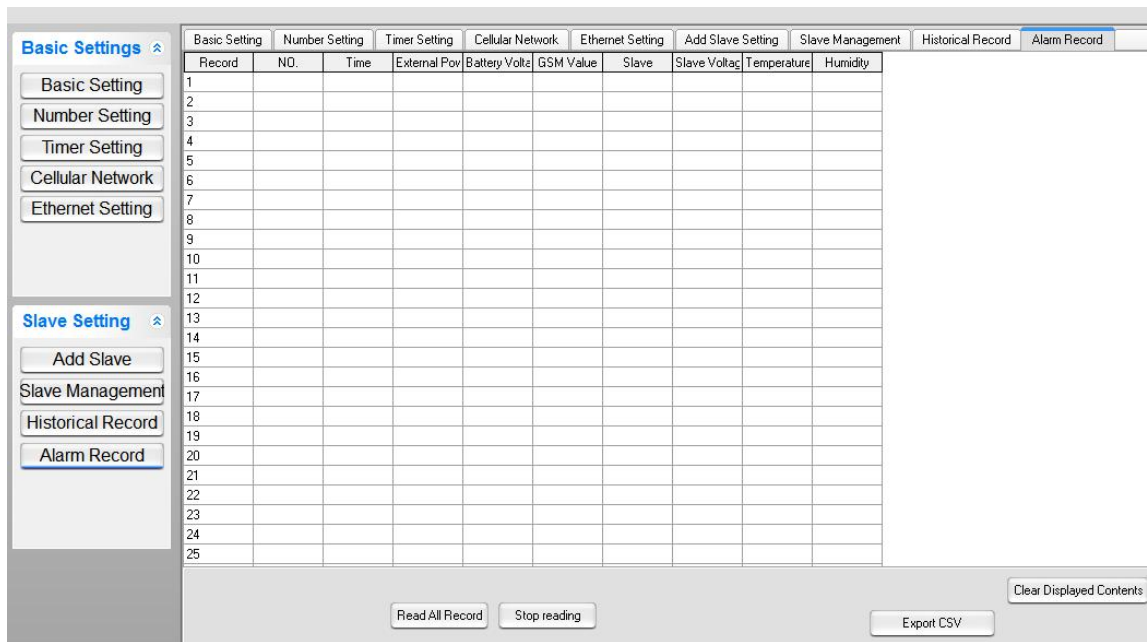

Record	NO.	Time	External Pow	Battery Voltz	GSM Value	Slave	Slave Voltage	Temperature	Humidity
1									
2									
3									
4									
5									
6									
7									
8									
9									
10									
11									
12									
13									
14									
15									
16									
17									
18									
19									
20									
21									
22									
23									
24									
25									

Supports up to 500 alarm records, mainly including terminal alarms, and low GSM signals.

- ◆ **Read all records:** display all history in the table;
- ◆ **Stop reading:** You can stop the reading process at any time.
- ◆ **Clear displayed content:** Empty the contents of the current form
- ◆ **Export CSV:** Export the contents of the table to a file in .XML format.

4.Update Firmware

S281 supports direct firmware upgrade via the USB port. If you have any new requirements to upgrade the firmware,
please contact us.

5.Warranty Terms

- 1) This gateway is with one year warranty from the date of purchase.
- 2) This one year's warranty does not cover any product failure caused by human damage or improper operation.

6.Technical Supports

King Pigeon Communication Co.,Ltd

Tel: +86-755-29451836 Technical@iot-solution.com

Website: www.iot-solution.com



Appendix A :SMS Commands

The SMS commands will be used for remote control the RTU as below, SMS Commands must be **CAP Locks**:

1)Commands error return SMS

Event	Return SMS Content
Any incorrect Command	SMS Format Error, Please check Caps Lock in Command!

2)External DC Status

Event	Return SMS Content
External DC goes off	External DC Power Goes OFF

3)External DC Power Lost Delay Time to Alarm

SMS Command		Return SMS Content
Set	password+ACxxx xxx stands for delay time, range 000~999 minutes. =000, stands for alarm immediately, =999 stands for DC power lost will not alarm. Default is 000.	External DC Power Lost Delay time to Alarm: xxx minutes
query	password+AC	External DC Power Lost Delay time to Alarm: xxx minutes

4)Modify Password, 4digits, default is 1234

SMS Command	Return SMS Content
Old Password+P+New Password	This is the New Password, please remember it carefully.

5)Set Device ID Number

SMS Command		Return SMS Content
Set	password+ IDxxxxx xxxxx=1~65535. Default is 1.	ID:XXXXX
query	password+IDE	ID:XXXXX

6) Set Gateway Time

Format is 2015-05-22 15:20:30W01, the W01 stands for Monday, W07 stands for Sunday.

SMS Command	Return SMS Content
-------------	--------------------



Set	password+DxxxxxxTyyyy Note: xxxxxx = year,month,date,time Yyyy=hour,minute Each unit occupies two position, put 0 before 1bit	xxxx(Y)XX(M)XX(D)xx(H)X(M)
query	password+D	Same as above

7) query Current Status SMS Command

SMS Command		Return SMS Content
query	password+EE	Time Device ID: GSM Signal Value: External DC Power Goes OFF/ON Model: Version: Device Description:

8) Set User Alarm Number

(Alarm Number&Access Control Number), max 21digits. (Return 1~5 or 6~10 separately while setting.)

SMS Command		Return SMS Content
Set	password+A+series number+T+tel number	Tel1: ---
	Notice:The number can support 21 digits,support plus country code,	Tel2: ---
	example: 0086; serial number: from 01 to 10 (two digits), A, T fixed	Tel3: 008613570810254 (Example)
	characters. The first 5 numbers are set then send back 5, and the last 5	Tel4: ---
	numbers are returned when 5 are set.	Tel5: ---
query	password+A	Return all numbers
Delete	password+A+series number (same as above)	same as above

9) Set Daily Report Time

SMS Command		Return SMS Content
Set	password+DRT+xx+yy Notice: xx =00~23, stands for hour. yy=00~59,stands for minutes. Default is 10:00	Daily SMS Report at: xx:xx
query	password+DRT	Same as above
Delete	password+DRTDEL (not to report)	



10) Set Periodically SMS Report Interval Time

SMS Command		Return SMS Content
Set	password+DTxxxxx Notice: xxxxx=0~65535minutes, 0=stands for disable, default is 0.	Periodically SMS Report interval time is: xxxxx minutes
query	password+DT	Same as above

11) Set Cellular Server IP and port configuration and Domain Name

SMS Command		Return SMS Content
Set	password+IP+IP address*+port number Note: IP,* fixed digital	Server: Port:
Query	Password +IP	Same as above
Delete	Password +APDEL	Sam as above

12) Set Cellular parameters (APN/USER NAME/PASSWORD)

SMS Command		Return SMS Content
Set	Password+AP+Access point+ # + user name#+password Note: AP,# fixed digital	APN: User name: Password:
Query	Password +AP	Same as above
Delete	Password +APDEL	Same as above

13)GPRS Online

SMS Command		Return SMS Content
	Password+GPRS Online	GPRS/3G Online

14) Configure cellular network, network port communication protocol, and enable

SMS Command		Return SMS Content
Enable	Cellular network: password+GPRSON1 Ethernet:password+ETHON1	GPRS ON Ethernet ON
OFF	Password+GPRSOFF Password+ETHOFF	GPRS/3G OFF Ethernet OFF
Query GPRS	Password + INTE Note: INTE fixed digital	Same as above



open/close status		
-------------------	--	--

15) Set Ethernet Parameter ,IP,admin and Server port

SMS Command		Return SMS Content
Set Ethernet IP	password+ETHP+ IP address+*+Server port Note: ETHIP	Local IP: Port:
query	password+ETHIP	
Delete	password+ETHIPDEL	

16) After the cellular network is disconnected, Set reconnect time

SMS Command		Return SMS Content
Set	password+RECONTxxxxxx Notice: xxxxxx=0~99999 seconds, 99999 means not connect default:600 seconds, Unit: second.	automatically connect time: second
query	password+RECONT	

17) Reboot

SMS Command		Return SMS Content
	Password+REBOOT	Reboot successfully

18) Factory Reset

SMS Command		Return SMS Content
	Password+RESET	Reset successfully

19) SMS query register current value

SMS	Command	Return SMS Content
Query	Password +RCU+XX-YY-ZZ... Note: RCU fixed characters, xx, yy, zz... represent slave device address, which is divided into 01-99. Two digital, query the slave device address, directly reply to the corresponding register of the slave device, be able to query separately and multiple . eg, query equipment 1 and 8: 1234RCU0108	R1: xxxxx (Y) R2: xxxxx (Y) Rx: xxxxx (N) Note: Y means normal, N means alarm



20) Delete slave device Instruction

SMS Command		Return SMS Content
Set	Password +DELDEVxx Note:xx,1-99,device ID,can only be deleted one by one separately	device: xx, deleted successfully

21) Query gateway and slave device communication status

SMS Command		Return SMS Content
Query	Password+RCUC Note:query gateway and slave device communication status	If the communication resumes normally, the SMS reply: the slave device communication is normal. If the slave device communication is not normal, the SMS reply: device ID: xx, yy zz... communication is abnormal.

Appendix B Local Modbus Register Address

S281 has no I/O port. The register is mainly used to map and store the temperature, humidity and voltage values of the terminal.

Input register support function code 04

Mapping address	Slave number	Data Point	Data Type	Description
9C40H	Slave 1	Temperature	16-bit signed integer	True value = this value/10
9C41H		Humidity	16-bit signed integer	True value = this value/10
9C42H		Voltage	16-bit signed integer	True value = this value/10
9C43H	Slave 2	Temperature	16-bit signed integer	True value = this value/10
9C44H		Humidity	16-bit signed integer	True value = this value/10
9C45H		Voltage	16-bit signed integer	True value = this value/10
9C46H	Slave 3	Temperature	16-bit signed integer	True value = this value/10
9C47H		Humidity	16-bit signed integer	True value = this value/10
9C48H		Voltage	16-bit signed integer	True value = this value/10
.
.
.
9D66H	Slave 100	Temperature	16-bit signed integer	True value = this value/10
9D67H		Humidity	16-bit signed integer	True value = this value/10
9D68H		Voltage	16-bit signed integer	True value = this value/10

Appendix C Communication Protocol

The S281 supports the Modbus TCP protocol and the Modbus RTU protocol, which can be connected to the user's SCADA and HMI through cellular or Ethernet network.

1.Modbus RTU Protocol

Function Code 04H(0x04): Read input register(Read slave device register temperature humidity voltage parameters)

Send content	Bytes	Send Data	Remark
Device Address	1	01H	Device No. 01, range: 1-247, subject to the set address
Function code	1	04H	Read input register
Start register address	2	9C 40H	Range: 9C40H-9C43 (40000-40002) , 00 10. See as explained above . Data transmission order: high byte first, such as 0010, then order:0010.
Read register Numbers	3	00 03H	Range: 0000H-0003H, read gateway data, Datatransmission order:highbyte first,suchas0008,then order:00 08.
CRC	2	9F 8FH	According to the actual situation check, the low byte is in front

Receive device return message format :

Send content	Bytes	Send Data	Remark
Device Address	1	01H	01 device The device address assigned by the cloud platform must be the same as the address set by the configuration software.
Function code	1	04H	Read input register
Return byte length	1	06H	Data: 2N, N is query registers number
Return data	6	0136H01F8H 0020H	From left to right, every 2 bytes represents a gateway register parameter. 0131H: 305, temperature 30.5C; 0244H: 580, humidity 58.0% RH; 0020H:32, voltage 3.2V
CRC	2	28 93H	According to the actual situation check, the low byte is in front

2.Modbus TCP Protocol



Send content	Bytes	Send Data	Remark
Command counter	1	00 00H Start	Every time send out a packet, the value of the counter is incremented by 1.
Command counter	1		
Fixed Digital	1	00H	Fixed format, fixed character
Fixed Digital	1	00H	Fixed format, fixed character
SMS content length	1	00 06H	Fill in according to the bytes in the following content
SMS content length	1		
Device Address	1	01H	Device No. 01, range: 1-247, subject to the set address
Function Code	1	04	Read input register
Start register address	2	9C 40H	Range: 9C40H-9C43 (40000-40003), refer to the above corresponding explanation of the address. Data transmission order: high byte first, such as 0010, then order: 0010
Read register Numbers	3	00 03H	Range: 0000H-0004H, read the corresponding master parameters, data transmission order: high byte is first, such as 0008, then orderly: 00 08.

Receive device return message format

Send data	Bytes	Send data	Remark
Command counter	1	00 00H	The device address assigned by the platform must be the same as the address set by the configuration software.
Command counter	1		
Fixed Digital	1	00H	Fixed format, fixed character
Fixed Digital	1	00H	Fixed format, fixed character
SMS content length	1	00 0BH	Fill in according to the bytes in the following content
SMS content length	1		
Device address	1	01H	01 device The device address assigned by the platform must be the same as the address set by the configuration software.
Function Code	1	04H	Read input register
Return bytes length	1	06H	Data: 2N, N is query registers number
Return data	6	0126 024D 0022H	From left to right, every 2 bytes represents a gateway register parameter, the low byte is first, such as 00 01H, then the order: 01 00H. Specific explanation: 0126H:294, temperature: 29.4C 024DH: 589, humidity: 58.9% RH 0022H:34, voltage: 3.4V